

ПАПКА 16

ПРИЛОЖЕНИЕ 10 Други документи за
Позиция 1 и Позиция 2

ПРИЛОЖЕНИЕ 10.7 3p и 1p стопяеми
цилиндрични предпазител-прекъсвач-
разединители

Приложение 1

Приложение 2

Приложение 3

Приложение 4

Приложение 5

Приложение 6

10.7/1,2

FUSE SWITCH-DISCONNECTORS FOR CYLINDRICAL FUSE-LINKS UP TO 32 A

Fuse switch-disconnectors OPV10 are intended for cylindrical fuse-links PV10 size 10x38. They can safely switch off rated current and overcurrent up to 1.5 rated current and meet the requirements for safe disconnection. Inverse connection is permissible and it affects neither the technical parameters nor the safety of the operator.

- Switch-disconnectors OPV can be sealed in the closed state.
- The devices are designed as modular for 45 mm cutout in the switchboard.
- Optional light indication of fuse state.
- Mounted on „U“ rail of type TH35 according to EN 60715 or on the panel (steel rail recommended).
- Fuse-link state can be indicated by means of electronic signalling, see page D17.

Fuse switch-disconnectors

Type	Product code	I _n [A]	Number of poles	Weight [kg]	Package [pcs]
OPV10S-1	38819		1	0.100	12
OPV10-N	38825		N	0.107	12
OPV10S-1N	38820		1+N	0.187	6
OPV10S-2	38821	32	2	0.180	6
OPV10S-3	38822		3	0.280	4
OPV10S-3N	38823		3+N	0.360	3
OPV10S-4	38824		4	0.360	3

¹⁾ OPV10-N design is without the possibility of signalling of fuse state.

Accessories

Description	Type	Product code	Weight [kg]	Package [pcs]
Light indication, operating voltage 100 ÷ 500 V a.c., d.c.	S-OPV10	08703	0.002	1
Light indication, operating voltage 12 ÷ 48 V d.c., a.c. (+ pole up)	S-OPV10/48	11812	0.002	1
Light indication, operating voltage 12 ÷ 48 V d.c., a.c. (+ pole down)	S-OPV10/48PD	18234	0.002	1
1-pole interconnecting busbar, cross-section 12 mm ² , max. current 65 A, rated operating voltage 415 V, max. operating voltage 500 V, length 1 m	G1L-1000-12	37355	0.300	1
2-pole interconnecting busbar, cross-section 16 mm ² , max. current 80 A, rated operating voltage 415 V, max. operating voltage 500 V, length 1 m	G2L-1000-16	37361	0.477	20
3-pole interconnecting busbar, cross-section 10 mm ² , max. current 63 A, rated operating voltage 415 V, max. operating voltage 500 V, length 1 m	G3L-1000-10C	37365	0.300	1
End cap, for 1-pole busbars with diameter 10, 12, 16 mm ²	EKC-1	37383	0.0005	10
End cap, for 3-pole busbars with diameter 10 mm ²	EKC-3	37385	0.001	10
End cap, for 2-pole and 3-pole busbars with diameter 16 mm ²	EKC-2+3	37384	0.001	10
Terminal extension, for connection of conductor of cross-section up to 25 mm ²	AS-25-G	37390	0.012	10
Terminal extension, for connection of Cu/Al conductor of cross-section 2.5 ÷ 50 mm ²	AS-50-S-AL01	38749	0.02	10
Adapter for busbars with spacing 60 mm, busbar thickness 5 or 10 mm, busbar width 12 ÷ 30 mm, cable outlet bottom, max. current 63 A	GA-60/63/54-1x7,5	11883	0.560	1

БЪЛГАРСКО ОПИГИНАЦИЯ

Specifications

Rated operating current	I _n	32 A
Rated operating voltage (a.c./d.c.)	U _n	690 V
Utilization category		690 V a.c.
		AC-21B
		DC-21B
		DC-20B
Rated thermal current with fuse-link	I _{th}	32 A
Rated frequency	f _n	40 ÷ 60 Hz
Rated insulation voltage	U _i	800 V a.c.

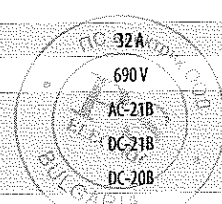

Handwritten signature

1

Handwritten signature

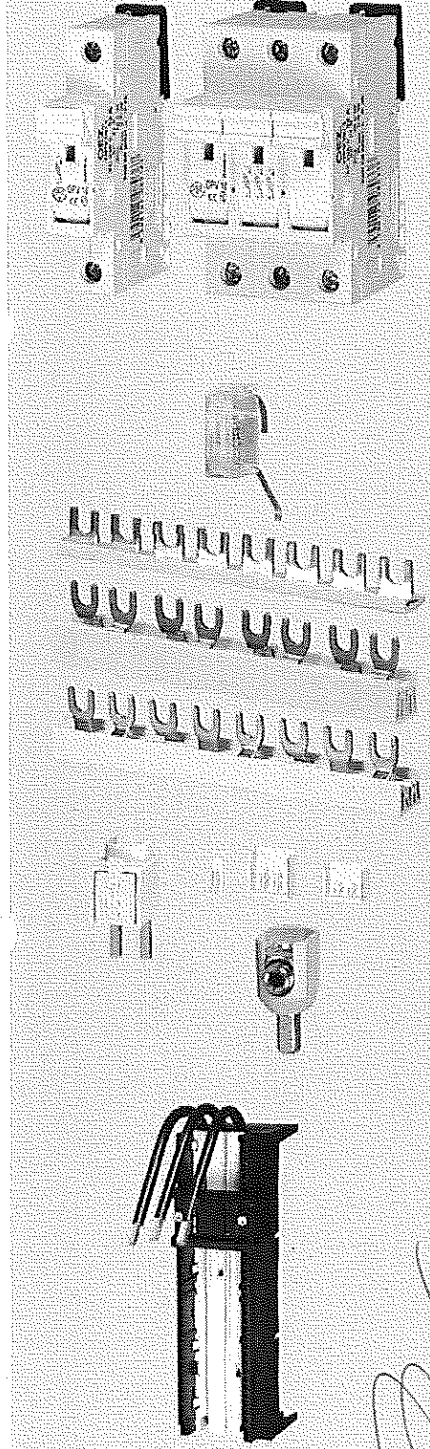

FUSE SWITCH-DISCONNECTORS FOR CYLINDRICAL FUSE-LINKS UP TO 32 A

Specifications

Rated conditional short-circuit current with fuse-links PV (RMS)	I_{cc}	690 V	110 kA
Rated pulse withstand voltage	U_{imp}		4 kV
Fuse-link size	diameter x length		10x38
Max. rated current of the fuse-link	I_n		32 A
Max. power losses of the fuse-link**	P_{ν}		3.5 W
Rated short-time withstand current	$I_{cw} 1s$		1.6 kA
Rated short-circuit making capacity at 400 V a.c.	I_{cm}		4 kA
Electrical endurance			300
Mechanical endurance			1700
Degree of protection, cover closed			IP20
Degree of protection, cover opened			IP20
Connection cross-section			Cu/0.5 ± 25 mm ² (2x 16 mm ²)
Torque			2 Nm
Operating ambient temperature	t		-25 ÷ +55 °C
Max. sea level			2000 m
Seismic resistance according to VE ŠKODA			3 g/8 ÷ 50 Hz
Overvoltage category/Rated voltage			I (II*)/690 V a.c., II (III*)/500 V a.c., III/400 V a.c.
Standards			IEC 60947-1, -3; EN 60947-1, -3
Approval marks			

* For underground cable distribution systems with overvoltage protection or for exposure to a low thunderstorm electricity (table H2 EN 60947-1, IEC 60947-1).

** Conditions for the use of fuse-links for semiconductor protection PV510 in chapter „Conditions for the use of fuse-links in fuse switch-disconnectors” see page H33.

EN 60947-3 ed. 2/A2, p. C.5 Instructions for the use of 1-pole controlled devices states:

These devices are intended for distribution systems, with possible necessity of switching and/or safe disconnection of individual phases, and must not be used for switching a primary circuit of a three-phase equipment.

Reduction of rated current of fuse-links PV gG, aM according to the number of poles

Type	I_n [A]	Reduced rated current [A]				
		(Number of poles)				
		1	3	5	7	10
OPV10	32	32	32	32	32	32

Neutral pole

	OPV10-N
Rated operating current	I_n 32 A
Thermal current with disconnecting link ZPV10	I_b 110 A/25 mm ²
Utilization category of the neutral pole at I_n	AC-20B
Rated short-time withstand current	$I_{cw} 1s$ 1.6 kA
Rated short-circuit making capacity at 690 V a.c.	I_{cm} [kA] 5 kA
Rated short-circuit making capacity at 250 V d.c.	I_{cm} [kA] 5.1 kA
Power losses with disconnecting link at I_n	P_{ν} [W] 4.8 W
Connection cross-section	0.5 ± 25 mm ²

Dimensions

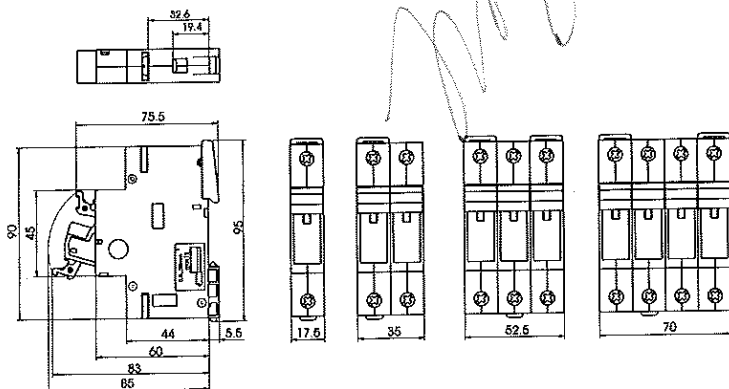

Diagram

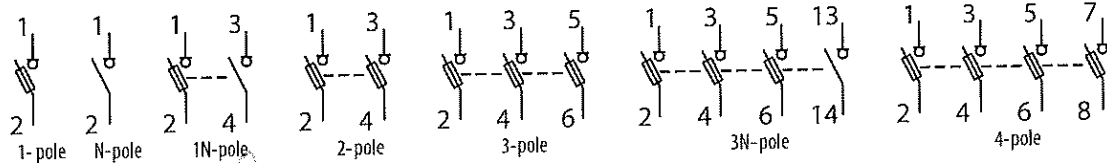

G1L-1000-12

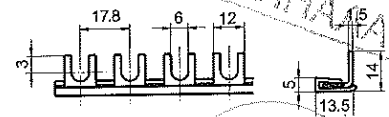

G2L-1000-16

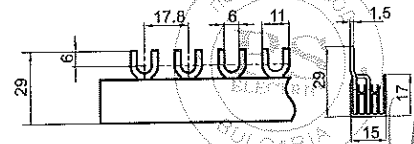

G3L-1000-10C

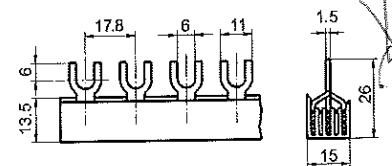

MINIMAL CONNECTING CROSS-SECTION OF FUSE SWITCH-DISCONNECTORS

Minimal connecting cross-section of cables of fuse switch-disconnectors for cylindrical fuse-links

Fuse-links I _n [A]	Fuse switch-disconnectors for cylindrical fuse-links			Cable S [mm ²]	
	OPV10	OPV14	OPV22	Cu	Al
0.25	x	x		1	-
0.5	x	x		1	-
1	x	x		1	-
2	x	x		1	-
4	x	x		1	-
6	x	x		1	-
8	x	x		1	-
10	x	x		1.5	-
12	x	x		1.5	-
16	x	x	x	2.5	-
20	x	x	x	2.5	-
25	x	x	x	4	-
32	x	x	x	4	-
40		x	x	10	-
50		x	x	10	16
63		x	x	16	25
80			x	25	35
100			x	35	50
125			x	50	70

Notes:

- 1) Applies to ambient temperature of switch-disconnectors max. 40 °C
- 2) Applies to HRC fuse-links PV10, PV14, PV22

Minimal connecting cross-section of cables and busbars of fuse switch-disconnectors and fuse rails

Fuse-links I _n [A]	Fuse switch-disconnectors and fuse-rails										Cable S [mm ²]		Busbar w x h	
	FH000	FH00	FH1	FH2	FH3	FDD0 FR00	FD1 FR1	FD2 FR2	FD3 FR3	Cu	Al	Cu	Al	
4	x	x				x				1	-	-	-	
6	x	x	x			x	x			1	-	-	-	
8	x	x	x			x	x			1	-	-	-	
10	x	x	x			x	x			1.5	-	-	-	
12	x	x	x			x	x			1.5	-	-	-	
16	x	x	x			x	x			2.5	-	-	-	
20	x	x	x			x	x			2.5	-	-	-	
25	x	x	x			x	x			4	-	-	-	
32	x	x	x	x		x	x	x		4	-	-	-	
35	x	x	x	x		x	x	x		6	-	-	-	
40	x	x	x	x		x	x	x		10	-	-	-	
50	x	x	x	x		x	x	x		10	16	-	-	
63	x	x	x	x		x	x	x		16	25	-	-	
80	x	x	x	x	x	x	x	x	x	25	35	-	-	
100	x	x	x	x	x	x	x	x	x	35	50	20 x 2	25 x 2	
125	x	x	x	x	x	x	x	x	x	50	70	25 x 2	25 x 3	
160	x	x	x	x	x	x	x	x	x	70	95	25 x 3	25 x 4	
200			x	x	x		x	x	x	95	120	25 x 4	25 x 5	
224			x	x	x		x	x	x	95	120	25 x 4	25 x 5	
250			x	x	x		x	x	x	120	150	25 x 5	25 x 6	
315				x	x			x	x	150	185	32 x 5	32 x 6	
350				x	x			x	x	185	240	32 x 6	32 x 8	
400				x	x			x	x	240	2x 150	32 x 8	40 x 8	
500					x				x	2x 150	2x 185	2x 30 x 5	2x 40 x 5	
630					x				x	2x 185	2x 240	2x 40 x 5	2x 40 x 8	

Notes:

- 1) Applies to ambient temperature of switch-disconnectors max. 40 °C
- 2) Applies to HRC fuse-links PNA, PHNA

ВАРІУС С
ОПВ14/22

Handwritten signature

3

Handwritten signature

FUSE-LINKS PV

- Small dimensions.
- High limiting and breaking capacity.
- Low power losses.
- The fuse-links do not contain harmful substances according to the RoHS Regulation (cadmium, lead and other).
- Utilization category gG for protection of lines, cables and other equipment against overload and short-circuit.
- Utilization category aM for protection of motors, overcurrent relays, contactors and similar devices only against short-circuit.

Fuse-links PV

I _n (A)	Utilization category gG				Utilization category aM				Weight (kg)	Package (pcs)
	Type	U _n (V)	Product code	Power losses (W)	Type	U _n (V)	Product code	Power losses (W)		
0,25	-	-	-	-	PV10 0,25A aM	500	06688	0,11	0,011	20
0,5	-	-	-	-	PV10 0,5A aM	500	06689	0,17	0,011	20
1	-	-	-	-	PV10 1A aM	500	06690	0,29	0,011	20
2	PV10 2A gG	500	06691	0,72	PV10 2A aM	500	06692	0,92	0,011	20
4	PV10 4A gG	500	06693	1,17	PV10 4A aM	500	06694	0,25	0,011	20
6	PV10 6A gG	500	06695	0,88	PV10 6A aM	500	06696	0,31	0,011	20
8	PV10 8A gG	500	06697	1,04	PV10 8A aM	500	06698	0,46	0,011	20
10	PV10 10A gG	500	06699	1,29	PV10 10A aM	500	06700	0,46	0,011	20
12	PV10 12A gG	500	06701	1,48	PV10 12A aM	500	06702	0,47	0,011	20
16	PV10 16A gG	500	06703	1,86	PV10 16A aM	500	06704	0,67	0,011	20
20	PV10 20A gG	500	06705	2,20	PV10 20A aM	400	06706	0,87	0,011	20
25	PV10 25A gG	500	06707	2,58	PV10 25A aM	400	06708	1,05	0,011	20
32	PV10 32A gG	500	06709	2,54	PV10 32A aM	400	06710	1,50	0,011	20
0,25	-	-	-	-	PV14 0,25A aM	690	06711	0,12	0,020	10
0,5	-	-	-	-	PV14 0,5A aM	690	06712	0,18	0,020	10
1	-	-	-	-	PV14 1A aM	690	06713	0,30	0,020	10
2	PV14 2A gG	690	06714	0,95	PV14 2A aM	690	06715	0,99	0,020	10
4	PV14 4A gG	690	06716	1,57	PV14 4A aM	690	06717	0,31	0,020	10
6	PV14 6A gG	690	06718	2,24	PV14 6A aM	690	06719	0,34	0,020	10
8	PV14 8A gG	690	06720	1,20	PV14 8A aM	690	06721	0,45	0,020	10
10	PV14 10A gG	690	06722	1,58	PV14 10A aM	690	06723	0,56	0,020	10
12	PV14 12A gG	690	06724	1,49	PV14 12A aM	690	06725	0,63	0,020	10
16	PV14 16A gG	690	06726	2,0	PV14 16A aM	500	06727	1,01	0,020	10
20	PV14 20A gG	690	06728	2,24	PV14 20A aM	500	06729	1,04	0,020	10
25	PV14 25A gG	690	06730	2,70	PV14 25A aM	500	06731	1,30	0,020	10
32	PV14 32A gG	690	06732	3,33	PV14 32A aM	500	06733	1,94	0,020	10
40	PV14 40A gG	500	06734	3,86	PV14 40A aM	500	06735	2,04	0,020	10
50	PV14 50A gG	500	06736	4,10	PV14 50A aM	400	06737	2,91	0,020	10
63	PV14 63A gG	500	06738	5,35	PV14 63A aM	400	06739	3,69	0,020	10
16	PV22 16A gG	690	06740	2,23	PV22 16A aM	690	06741	0,92	0,060	10
20	PV22 20A gG	690	06742	2,24	PV22 20A aM	690	06743	1,06	0,060	10
25	PV22 25A gG	690	06744	2,90	PV22 25A aM	690	06745	1,43	0,060	10
32	PV22 32A gG	690	06746	4,10	PV22 32A aM	690	06747	2,03	0,060	10
40	PV22 40A gG	690	06748	4,52	PV22 40A aM	690	06749	2,50	0,060	10
50	PV22 50A gG	690	06750	6,45	PV22 50A aM	690	06751	2,55	0,060	10
63	PV22 63A gG	500	06752	5,82	PV22 63A aM	500	06753	4,05	0,060	10
80	PV22 80A gG	500	06754	6,82	PV22 80A aM	500	06755	4,85	0,060	10
100	PV22 100A gG	500	06756	7,81	PV22 100A aM	500	06757	5,59	0,060	10
125	PV22 125A gG	500	18271	10,5	PV22 125A aM	400	06758	6,31	0,060	10



Handwritten signature

Handwritten signature

FUSE-LINKS PV

Parameters

Rated voltage	U_n	400 + 690 V a.c. 250 V d.c.
Rated breaking capacity (rms)	I_b	120 kA/400 + 690 V a.c. (100 kA/PV10 32A gG, 80 kA/PV14 63A gG) 50 kA/250 V d.c.
Utilization category		gG aM
Discrimination		1 : 1.6
Standards		IEC 60269 EN 60269

Approval marks



Dimensions

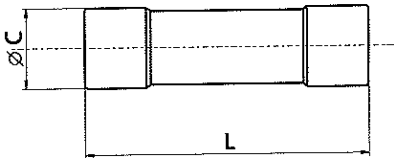

Type	ϕC	L
PV10	10.3 ± 0.1	38 ± 0.6
PV14	14.3 ± 0.1	$51^{+0.6}_{-1}$
PV22	22.2 ± 1	$58^{+0.1}_{-2}$

Characteristics

Prearcing time/current characteristic
PV10 gG

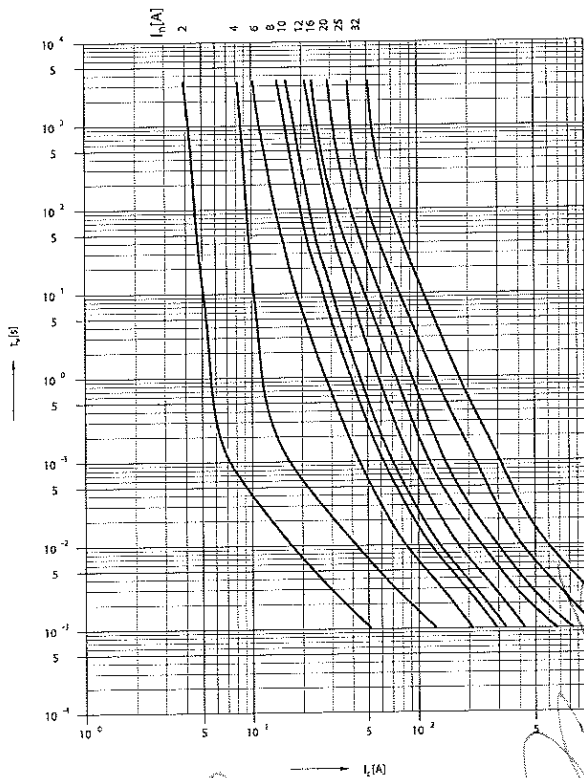

Prearcing time/current characteristic
PV14 gG

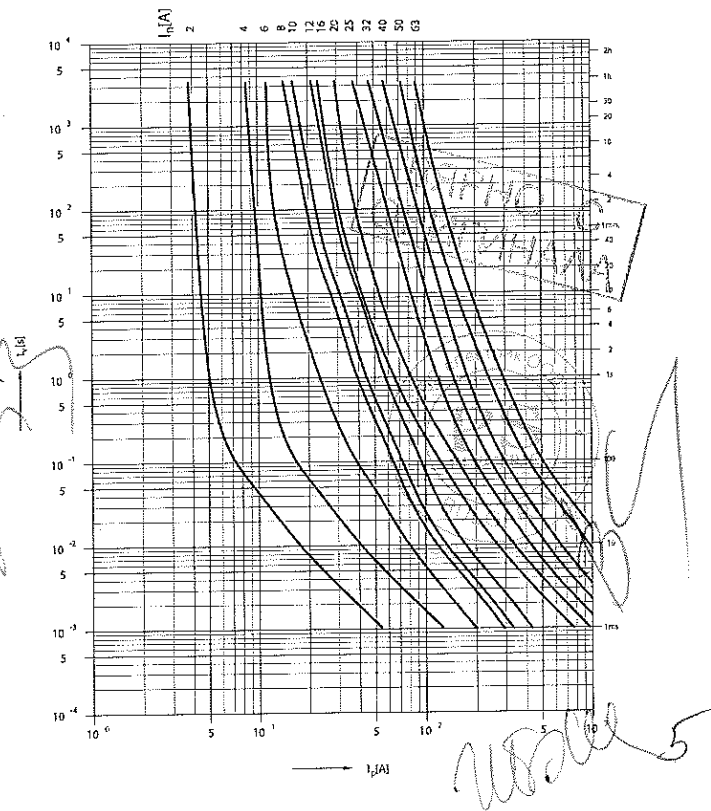

FUSE-LINKS PV

Characteristics

Prearcing time/current characteristic
PV22 gG

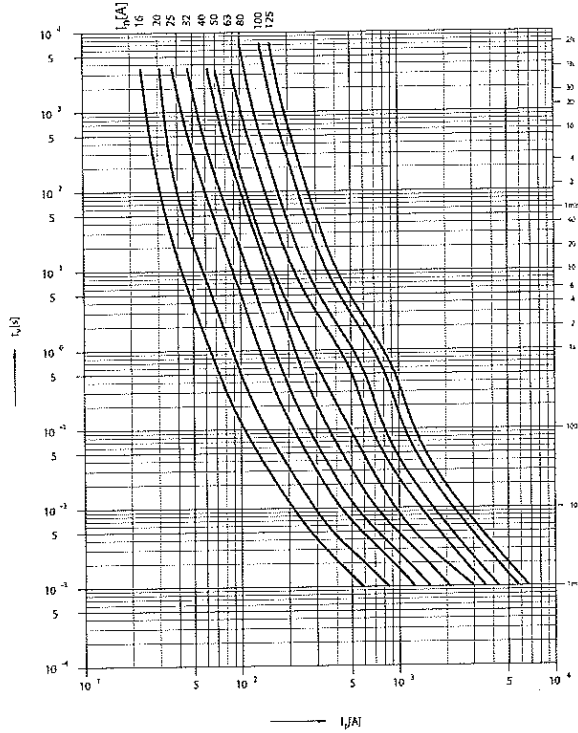

Cut-off characteristic
PV10, 14, 22 gG pro 500 V a.c.

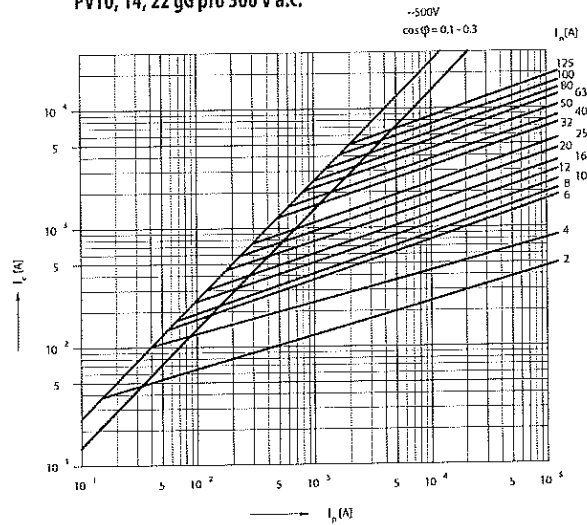

Cut-off characteristic
PV10, 14, 22 gG pro 690 V a.c.

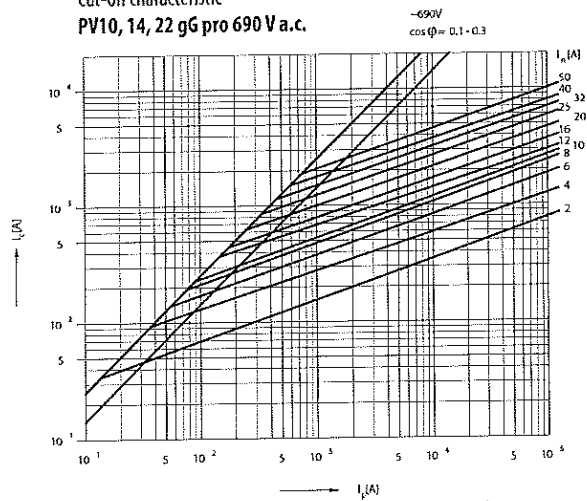

I²t characteristic
PV10, 14, 22 gG pro 500 V a.c.

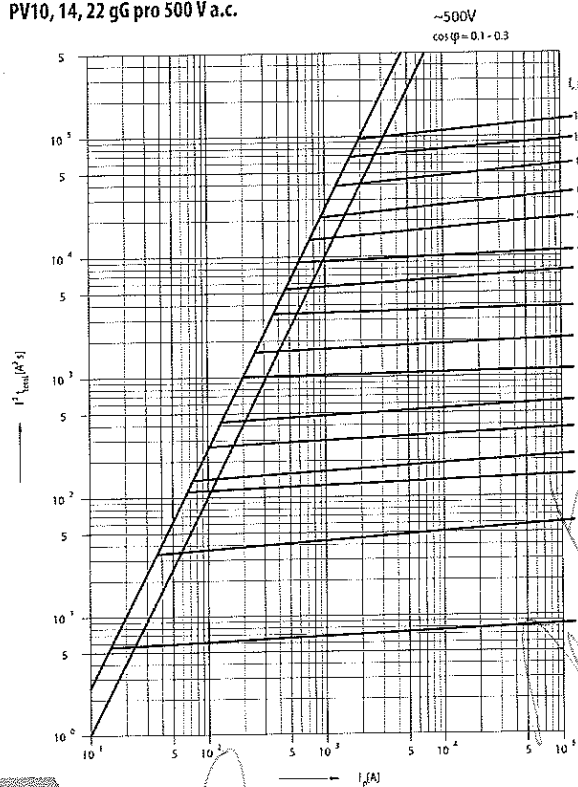

I²t characteristic
PV10, 14, 22 gG pro 690 V a.c.

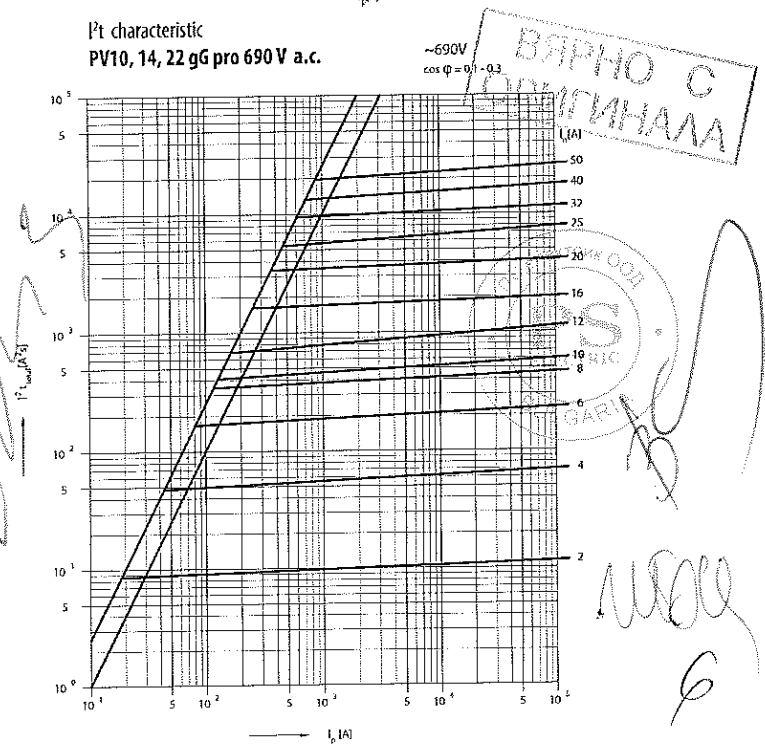

FUSE-LINKS PV

Characteristics

Correction factor „k“ of I²t dependence on operating voltage U

$$(I^2 t)_{total} / (I U) = k \times I^2 t_{total}$$

PV10, 14, 22 gG, aM

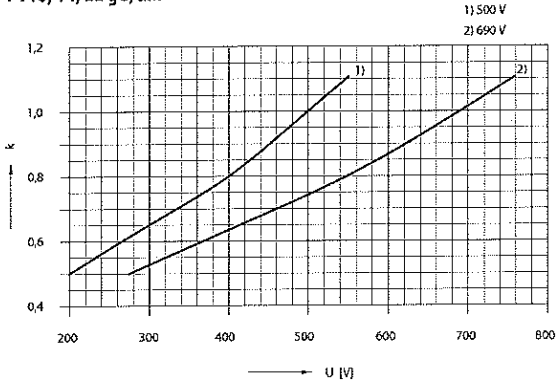

Prearing time/current characteristic
PV14 aM

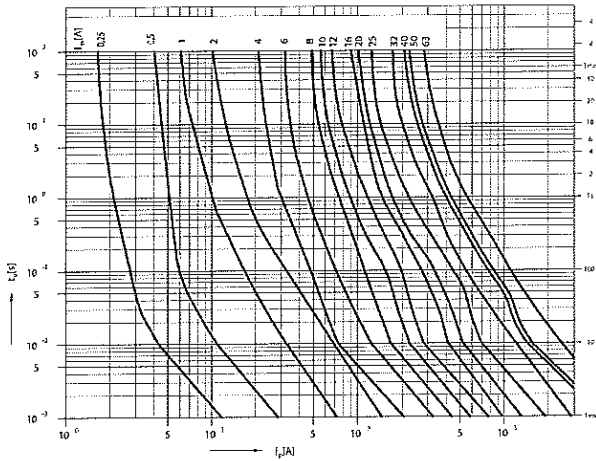

Prearing time/current characteristic
PV22 aM

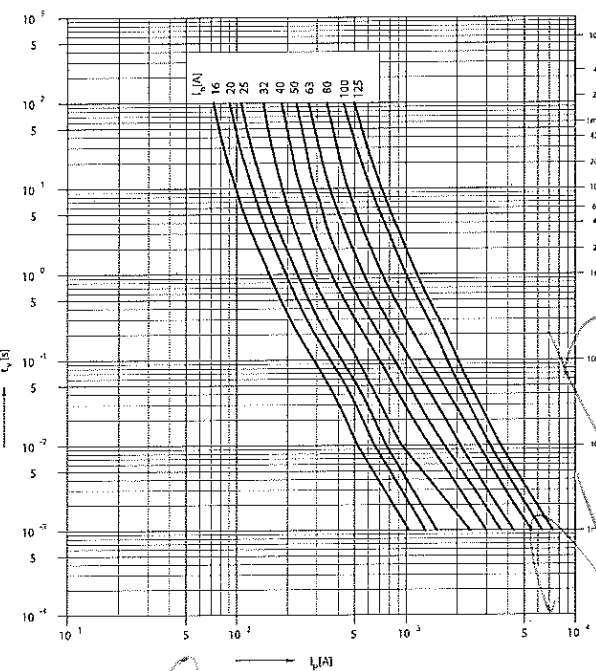

Prearing time/current characteristic
PV10 aM

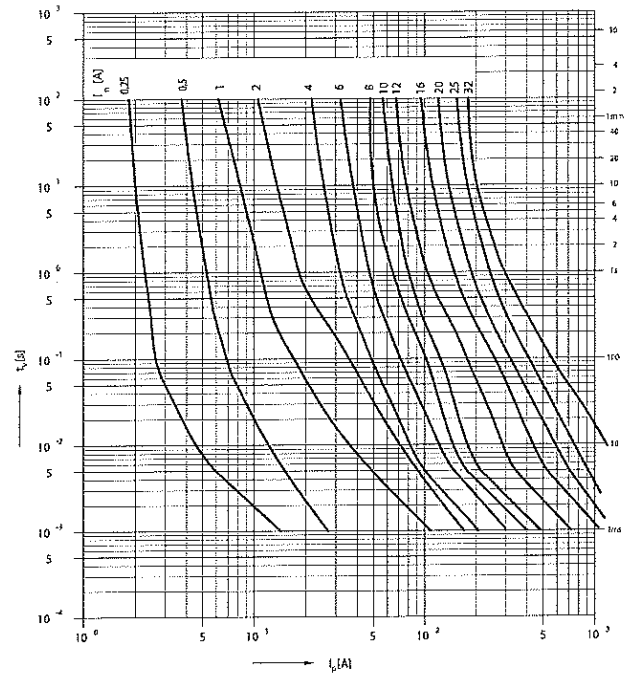

Time/current ranges
PV10, 14, 22 aM

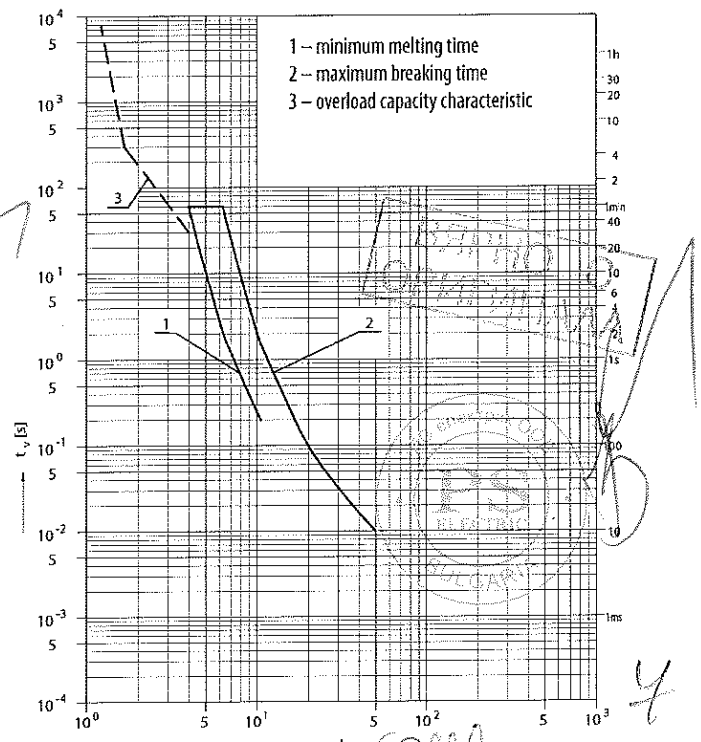

FUSE-LINKS PV

Characteristics

Cut-off characteristic
PV10, 14, 22 aM

PV10 20 ÷ 32 A for 400 V a.c. PV22 125 A for 400 V a.c.
 PV14 50 a 63 A for 400 V a.c. PV22 16 ÷ 50 A for 690 V a.c.
 PV14 0.25 ÷ 12 A for 690 V a.c.

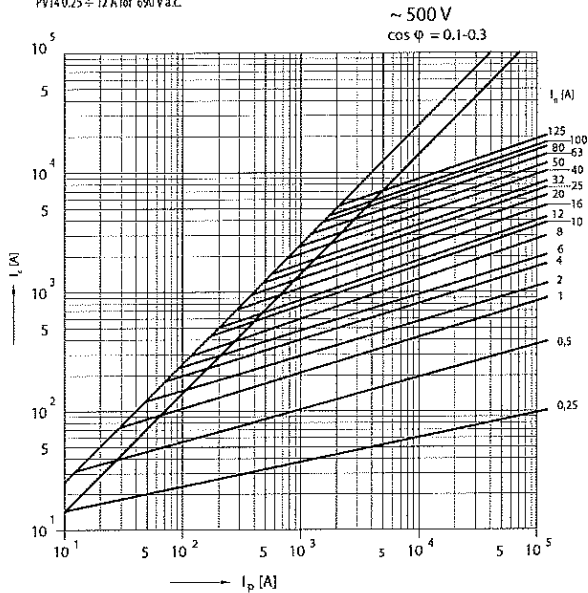

I²t characteristic
PV10 aM

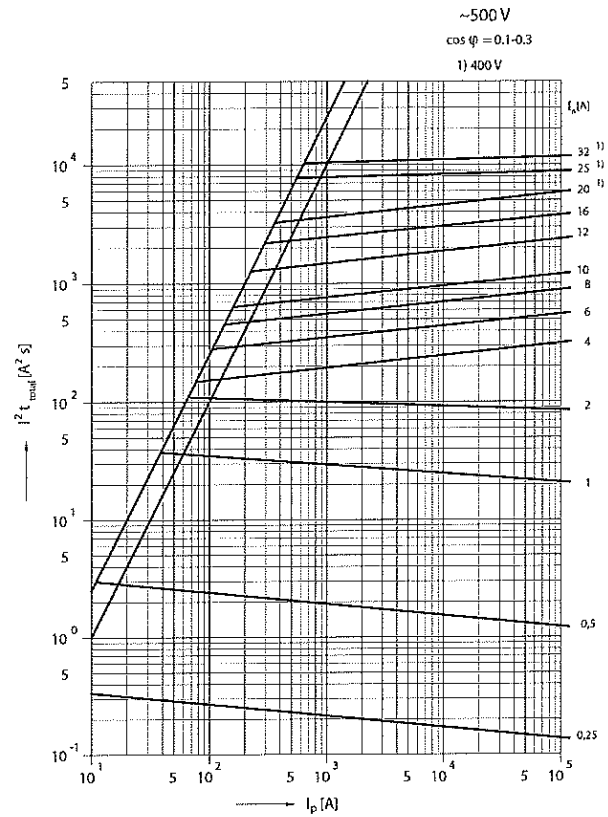

I²t characteristic
PV14 aM

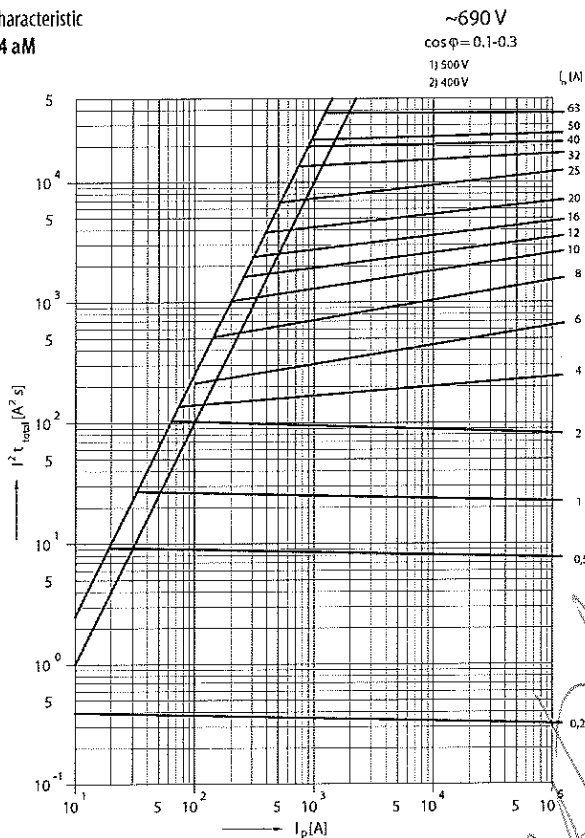

I²t characteristic
PV22 aM

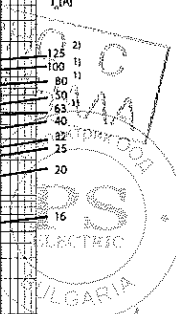
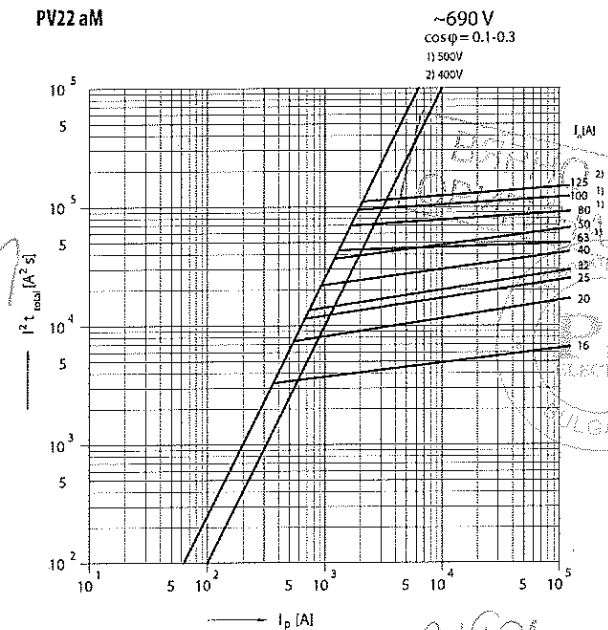



10.4/3

ES PROHLÁŠENÍ O SHODĚ / CE DECLARATION OF CONFORMITY
Číslo / No. : 502300/1210

My / We, **OEZ s.r.o.**
Šedivská 339, 561 51 Letohrad, Česká republika

prohlašujeme na svou výlučnou odpovědnost, že
declare on our own responsibility that

Výrobek: Odpínače válcových pojistek velikosti 10x38
Product: Fuse switch-disconnectors for cylindrical fuse-links size 10x38

Typ / Type: OPVA10

Příslušenství / Accessory:

je ve shodě s následujícími normami:
complies with the following standards:

České normy / Czech standards	Evropské normy / European standards
ČSN EN 60947-1:08ed.4 +A1:11 ČSN EN 60947-3:10ed.3	EN 60947-1:07 EN 60947-3:09

a následujícími nařízeními vlády, ve znění pozdějších předpisů (NV)
and the following government regulations (NV), as amended

NV 17/2003 Sb. v platném znění	2006/95/ES - including amendments
--------------------------------	-----------------------------------

Elektrotechnický zkušební ústav, Pod Lisem 129, 171 02 Praha 71, Česká republika
zkoušel / certifikoval daný výrobek a vydal:
tested / certified the product and issued:

EZU Certifikát / EZU Certificate: 1120754 ze dne 29.09.2012
EZU zkušební protokol / EZU test report: 204265-01/01 ze dne 21.09.2012

Poslední dvojčíslí roku, v němž bylo označení CE na výrobek umístěno: 12
Last two digits of the year in which the CE mark was placed on the product:

Místo vydání: Letohrad
Place of issue:
signature:

Zástupce výrobce a podpis
Manufacturer's representative and

Datum vydání: 08.10.2012
Date of issue:

Funkce: generální ředitel
Position: general director

На основании чл. 2
от ЗЗЛД

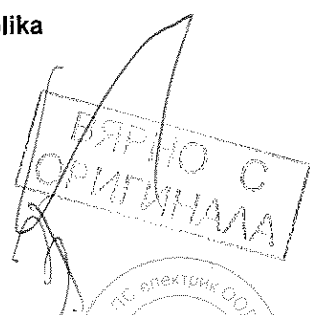

Handwritten signature



ES PROHLÁŠENÍ O SHODĚ / CE DECLARATION OF CONFORMITY
Číslo / No. : 493200/1210

My / We, **OEZ s.r.o.**
Šedivská 339, 561 51 Letohrad, Česká republika

prohlašujeme na svou výlučnou odpovědnost, že
declare on our own responsibility that

Výrobek: Pojistkové vložky
Product: Fuse-links

Typ / Type: PVA

Příslušenství / Accessory:

je ve shodě s následujícími normami:
complies with the following standards:

České normy / Czech standards	Evropské normy / European standards
ČSN EN 60269-1:08ed.3 ČSN 354701-2:11ed.2	EN 60269-1:07 HD 60269-2:10

a následujícími nařízeními vlády, ve znění pozdějších předpisů (NV)
and the following government regulations (NV), as amended

NV 17/2003 Sb. v platném znění	2006/95/ES - including amendments
--------------------------------	-----------------------------------

Elektrotechnický zkušební ústav, Pod Lisem 129, 171 02 Praha 71, Česká republika
zkoušel / certifikoval daný výrobek a vydal:
tested / certified the product and issued:

EZU Certifikát / EZU Certificate: 1120633 ze dne 14.8.2012
EZU zkušební protokol / EZU test report: 203275-01/01 ze dne 30.07.2012

Poslední dvojčíslí roku, v němž bylo označení CE na výrobek umístěno: 12
Last two digits of the year in which the CE mark was placed on the product:

Místo vydání: Letohrad
Place of issue:
signature:

Datum vydání: 08.10.2012
Date of issue:

Zástupce výrobce a podpis:
Manufacturer's representative and

Funkce: generální ředitel
Position: general director

На основании чл. 2
от ЗЗЛД



Превод от английски език

ОЕЗ АД
Шедивска 339, 561 51 Летоград, Чешка република

ДЕКЛАРАЦИЯ ЗА СЪОТВЕТСТВИЕ
№ 502300/1210

Ние, **ОЕЗ АД**, с адрес: Шедивска 339, 561 51 Летоград, Чешка република, декларираме на наша собствена отговорност, че

Продуктът **Разединител - предпазител за цилиндрични стояеми вложки**
размер 10x38

Тип **OPVA10**

Акcesoари:

Съответства на следните стандарти:

Чешки стандарт	Европейски стандарт
CSN EN 60947-1:08 ed.4+A1:11	EN 60947-1:07
CSN EN 60947-3:10 ed.3	EN 60947-3:09

И на следните държавни наредби (NV) и измененията към тях

NV17/2003 Sb. - включително измененията	2006/95/ES - включително измененията
---	--------------------------------------

ЕЗУ (Дружество за електротехнически изпитания) с адрес: Под Листем 129, 171 02 Прага 71, Чешка република, удостовери продукта и издаде:

Сертификат № 1120754 от дата 29.09.2012 г.
Изпитателен протокол № 204265-01/01 от дата 21.09.2012 г.

Последните две цифри от годината, в която е поставен знакът ЕС върху продукта: 12

Място на издаване: Летоград/ дата на издаване: 08.10.2012 г.
Представител на производителя: инж. Роман Шифер, генерален директор (подпис)
ОЕЗ АД с адрес: Шедивска 339, 561 51 Летоград, Чешка република

ВАРНО С
ОРИГИНАЛ



[Handwritten signatures and marks]

Превод от английски език

ОЕЗ АД

Шедивска 339, 561 51 Летоhrad, Чешка република

ДЕКЛАРАЦИЯ ЗА СЪОТВЕТСТВИЕ
№ 493200/1210

Ние, **ОЕЗ АД**, с адрес: Шедивска 339, 561 51 Летоhrad, Чешка република, декларираме на наша собствена отговорност, че

Продуктът **Стопяем предпазител**

Тип **PVA**

Акcesoари:

Съответства на следните стандарти:

Чешки стандарт	Европейски стандарт
CSN EN 60269-1:08 ed.3	EN 60269-1:07
CSN 354701-2:11 ed.2	HD 60269-2:10

И на следните държавни наредби (NV) и измененията към тях

NV17/2003 Sb. - включително измененията	2006/95/ES - включително измененията
---	--------------------------------------

ЕЗУ (Дружество за електротехнически изпитания) с адрес: Под Листем 129, 171 02 Прага 71, Чешка република, удостовери продукта и издаде:

Сертификат № 1120633 от дата 14.08.2012 г.

Изпитателен протокол № 203275-01/01 от дата 30.07.2012 г.

Последните две цифри от годината, в която е поставен знакът ЕС върху продукта: 12

Място на издаване: Летоhrad/ дата на издаване: 08.10.2012 г.

Представител на производителя: инж. Роман Шифер, генерален директор (подпис)
ОЕЗ АД с адрес: Шедивска 339, 561 51 Летоhrad, Чешка република

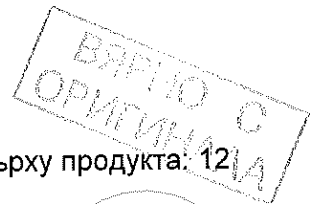

Handwritten signatures and initials scattered across the bottom half of the page, including a large signature on the left and another on the right.

10.7.4

Ref. No.: 702102-01/01

page - 1 / 78 -

TEST REPORT

IEC 60269-1:98 3rd ed.+ Amd1:05; IEC 60269-2: 2nd ed.+ Amd1:95+ Amd2:01; IEC 60269-2-1:04 4th ed.

Report

Reference No.: 702102-01/01
 Tested by (+ signature).....: Klípa
 Approved by (+ signature): Hlavatý
 Date of issue: 03.08, 2007
 Contents: 78 pages
 Oscillograms..... : 85, page 36 - 78

На основание чл. 2
от ЗЗЛД

Testing laboratory

Name.....: Elektrotechnický zkušební ústav
 Address: Pod Lisem 129, 171 02 Praha 8 - Troja, Czech Republic
 Testing location: as above

Client

Name.....: OEZ s.r.o.
 Address: Šedivská 339, 56151 Letohrad, Czech Republic

Test specification

Standard.....: IEC 60269-1:98 3rd ed.+Amd1:05; IEC 60269-2:86 2nd ed. +Amd1:95+ Amd2:01;
IEC 60269-2-1:04 4th ed..
 Test procedure: CB-scheme
 Procedure deviation.....: N.A.
 Non-standard test method.....: N.A.

Test item

Description.....: **Low-voltage fuses**
 Trademark.....: **OEZ**
 Model and/or type reference: **PV10 gG Cd/Pb free**
 Manufacturer: **OEZ s.r.o.**
 Rating(s): **500V / 2, 4, 6, 8, 10, 12, 16, 20, 25, 32A**

Test case verdicts

Test case does not apply to the test object: N(A.)
 Test item does meet the requirement.....: P(ass)
 Test item does not meet the requirement.....: F(ail)

ВЕРНО
ОРИГИНАЛ

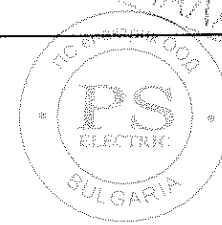

[Handwritten signatures and scribbles]

[Handwritten signature]

13

TEST REPORT

IEC 60269-1:98 3rd ed.+ Amd1:05; IEC 60269-2: 2nd ed.+ Amd1:95+ Amd2:01; IEC 60269-2-1:04 4th ed.

TECHNICAL CHARACTERISTIC

Serie/Type ref.:.....PV10gG Cd/Pb free

Rated voltage:500 V

Rated current:..... 2, 4, 6, 8, 10, 12, 16, 20, 25, 32A

Rated frequency:..... 50 Hz

Rated breaking capacity:.....120 kA (100kA/32A)

Homogeneous series.....2-4; 6; 8-12;16-20;25; 32A

Size:.....10 x 38

Utilization category:

Gripping lugs:.....No

Indicating device:.....No

Models/type see page 3

Test sequence see page 3

Handwritten signature

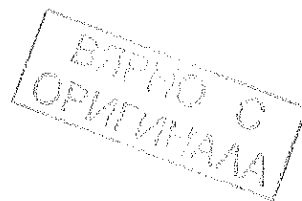

Handwritten signature

Handwritten signature

14

TEST REPORT

IEC 60269-1:98 3rd ed.+ Amd1:05; IEC 60269-2: 2nd ed.+ Amd1:95+ Amd2:01; IEC 60269-2-1:04 4th ed.

LOW-VOLTAGE FUSE; NH-SYSTEM
IEC 60269 Test sequence

Number of CB-Test report	Type	Rated current (A)	Rated voltage (V)	Rated breaking capacity (kA)	Size	Table
	PV10 gG	2	500	120	10x38	7B
	PV10 gG	4	500	120	10x38	7A
	PV10 gG	6	500	120	10x38	7A
	PV10 gG	8	500	120	10x38	7B
	PV10 gG	10	500	120	10x38	7C
	PV10 gG	12	500	120	10x38	7A
	PV10 gG	16	500	120	10x38	7B
	PV10 gG	20	500	120	10x38	7A
	PV10 gG	25	500	120	10x38	7A
	PV10 gG	32	500	100	10x38	7A

Type listing

Rated current (A)	Type	Type	Type	Type

БЪЛГАРСКО
 ЕЛЕКТРИЧЕСКО
 ОБЩЕСТВО

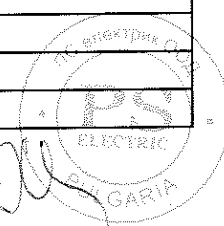

15

[Handwritten signature]

EZU Testing and Certification Institute
 Type of fuse: HRC-fuse ; Type PV10 gG ; 2A ; AC 500V ; Size 10x38
 Made by: OEZ Letohrad s.r.o.
 Tests according IEC 60269-1:98 3rd ed.+ Amd1:05; IEC 60269-2: 2nd ed.+ Amd1:95+ Amd2:01; table 7B
 IEC 60269-2-1:04 4th ed.
 CB
 Ref. No.: 702102-01/01
 Table No: 7B
 Checked by: J. Hlavaty
 Dated:03.08.07
 page - 4 / 78 -

Clause	Test-sequence	Samples No	R _i mΩ	Test-voltage V (AC)	Test-current A	cos φ	Pre-arcing time s	Operating time s	Requirement-Test	Result-Remark verdict
6	Marking	1							The marking of the rated voltage/rated current /size discernible from the front	P see page 34
8.1.4	Dimension	1-3							Fig. 1(III) Size 10 x 38	P see page 6
8.1.5.1	Resistance (R _i)	1-17							Measuring current ≤ 0,1 I _n ; Ambient air temperature 20 ± 5°C	P see page 4, 5
8.3	Power dissipation (P _n) / temperature rise (ΔT)	1	143	10	2	-			Tab. M and Fig. 1(III) (60269-2-1), P _n = max 3 W, Ambient air temperature: 24°C; Conventional time 1 h	P P _n = 0,72W ΔT = 9K
8.4.3.1a)	Conv. non-fusing current (I _{np})	1	143	10	3	-		> 3600	not operate within the conventional time 1h	P
8.4.3.1b)	Conv. fusing current (I _f)	2	129	10	4,2	-		1080	operate within the conventional time 1 h	P
8.4.3.2	Rated current	3	140	10	3	-		> 3600	100 h pulse test; test current 1,05 x I _n , 2,1A; on 1 h/ off 0,1 x 1h, after the test conventional non-fusing current (I _{np}) 3 A, conventional time 1h	P
8.4.3.3.1	Gate a) I _{min} (10 s)	4	135	10	3,7	-	>4200		Testing current of Table 3, column 2; operating time > 10 s	P
	b) I _{max} (5 s)	5	137	200	9,2	-	0,051		operate within ≤ 5 s	P
	c) I _{min} (0,1 s)	6	131	200	6	-	0,3		operate within > 0,1 s	P
	d) I _{max} (0,1 s)	7	132	200	23	-	0,006		operate within ≤ 0,1 s	P
8.4.3.4	Overload	8	140	10	4,2	-	1020		50 pulses; test current equal to 0,8 x 5,2 A stated for a pre-arcing time of 5 s	P
		9	138	10	4,2	-	1050		on - 5 s / off - 0,2 x 1 h of the conventional time; current 4,2 A equal to current for the overload test; pre-arcing time of sample lies within stated zone	P
		10	136	10	4,2	-	900		Operation of indicating device verified in combination with the verification of breaking capacity I ₁ to I ₅ (8.5.5)	P
8.4.3.6	Indicating devices	-								N

Handwritten signature and stamp area with a circular official seal and a rectangular stamp containing the text 'TESTED' and other illegible markings.

EZU Testing and Certification Institute	Type of fuse: HRC-fuse ; Type PV10 gG ; 2A ; AC 500V ; Size 10x38		CB	page - 5 / 78 -
	Made by: OEZ Letohrad s.r.o.		Ref. No.: 702102-01/01	
Tests according IEC 60269-1:98 3 rd ed.+ Amd1:05; IEC 60269-2: 2 nd ed.+ Amd1:95+ Amd2:01; IEC 60269-2-1:04 4 th ed.		table 7B	Table No: 7B	Dated:03.08.07
			Checked by: J., Hlavaty	

Clause	Test sequence	Sample No	R _i mΩ	Test-voltage V (AC)	Test-current kA	cos φ	Making angle after voltage zero (U ₀)	i _b kA	i _s kA	Peak arc voltage V	Initiation of arcing voltage zero (U ₀)	Pre-arcing time ms	Operating time ms	Pre-arcing I _t A ² s	Operating I _t A ² s	Osz No	Result-Remark
8.5 No1	Breaking capacity (I _t)	11	129	558	125	0,16	46	0,620		640	46	0,01	0,12			27DS044	Resistance between fuse-link contacts measured after each test. Test voltage DC 500 V
		12	130	558	125	0,16	86	0,623		916	86	0,01	0,15			27DS045	Verdict
		13	137	558	125	0,16	84	0,494		803	84	0,01	0,10			27DS046	Resistance >1000 MΩ
8.7.4	Overcurrent discrimination(I ² t-Wert)	14	140	192	0,013	0,26	0							3,10		98645	∞ MΩ
		15	141	192	0,013	0,26	0							2,89		98646	∞ MΩ
		16	131	320	0,066	0,25	7							3,66		98651	∞ MΩ
8.9.2	Resistance to heat	17	131	328	0,066	0,25	0							3,61		98652	∞ MΩ
8.11.1.8	Impact resistance																N
8.11.2.2	Resistance to abnormal heat and fire																N
8.11.2.4	Non-deterioration of insulating parts of fuse-link and fuse-base																N

ВЪРНО С
ОРИГИНАЛ



Handwritten signature

Handwritten mark

EZU Testing and Certification Institute	Type of fuse: HRC-fuse ; Type PV10 gG ; 2A ; AC 500V ; Size 10x38 Made by: OEZ Letohrad s.r.o. Tests according IEC 60269-1:98 3 rd ed.+ Amd1:05; IEC 60269-2: 2 nd ed.+ Amd1:95+ Amd2:01; IEC 60269-2-1:04 4 th ed.	CB Ref. No.: 702102-01/01 Table No: 7B Checked by: J., Hlavaty	page - 6 / 78 - Dated: 03.08.07
	table 7B		

Clause	Test sequence	Samples Nr	Requirement-Test	Deviations: Type: PV10 gG In = 2A			Result-Remark)	
				Prescribed (mm)	Measured (mm)	Verdict		
8.1.4	Dimensions	1-3	Fig. 1(III) Size 10 x 38					
				Dimension marking a	Samples Nr 1 37.4	Samples Nr 2 37.5	Samples Nr 3 37.7	P
				Dimension marking b	9.1	9	9.1	P
				Dimension marking c	10.2	10.2	10.2	P
				Dimension marking d	10.2	10.2	10.2	P
				Dimension marking r	1.2	1.3	1.3	P

Handwritten signature



Handwritten signature

Handwritten signature

page - 7 / 78 -

CB
Ref. No.: 702102-01/01
Table No: 7A
Checked by: J., Hlavaty **Dated: 03.08.07**

Type of fuse: HRC-fuse ; Type PV10 gG ; 4A ; AC 500V ; Size 10x38
Made by: OEZ Letohrad s.r.o.
Tests according
IEC 60269-1:98 3rd ed.+ Amd1:05; IEC 60269-2: 2nd ed.+ Amd1:95+ Amd2:01;
IEC 60269-2-1:04 4th ed. table 7A

Clause	Test-sequence	Samples No	R _i mΩ	Test-voltage V (AC)	Test current A	cos φ	Pre-arcing time s	Operating time s	Requirement-Test	Result-Remark verdict
6	Marking	1							The marking of the rated voltage/rated current /size discernible from the front	P see page 34
8.1.4	Dimension	1-3							Fig. 1(III) Size 10 x 38	P see page 9
8.1.5.1	Resistance (R _i)	1-23							Measuring current ≤ 0,1 I _n ; Ambient air temperature 20 ± 5°C	P see page 7, 8
8.3	Power dissipation (P _n) / temperature rise (ΔT)	1	54,0	10	4	-			Tab. M and Fig. 1(III) (60269-2-1), P _n = max 3 W, Ambient air temperature: 22°C; Conventional time 1 h	P P _n = 1,17W ΔT = 16K
8.4.3.1a)	Conv. non-fusing current (I _{np})	1	54,0	10	6	-		> 3600	not operate within the conventional time 1h	P
8.4.3.1b)	Conv. fusing current (I _f)	2	49,5	10	8,4	-		1140	operate within the conventional time 1.h	P
8.4.3.2	Rated current	3	53,8	10	6	-		> 3600	100 h pulse test; test current 1,05 x I _n 4,2 A ; on 1 hr off 0,1 x I _n , after the test conventional non-fusing current (I _{np}) 6 A; conventional time 1h	P
8.4.3.3.1	Gate a) I _{min} (10 s)	4	51,3	10	7,8	-	> 4200		Testing current of Table 3, column 2; operating time > 10 s	P
	b) I _{max} (5 s)	5	52,0	200	18,5	-	0,062		operate within ≤ 5 s	P
	c) I _{min} (0,1 s)	6	51,0	200	14	-	0,144		operating time > 0,1 s	P
	d) I _{max} (0,1 s)	7	51,5	200	47	-	0,008		operate within ≤ 0,1 s	P
8.4.3.4	Overload	8	50,8	10	8,6	7	390		50 pulses; test current equal to 0,8 x 10,8 A stated for a pre-arcing time of 5 s	P
		9	52,0	10	8,6	-	420		on - 5 s / off - 0,2 x 1 h of the conventional time; current 8,6 A equal to	P
		10	53,0	10	8,6	-	360		current for the overload test; pre-arcing time of sample lies within stated zone	P
8.4.3.6	Indicating devices	-	-						Operation of indicating device verified in combination with the verification of breaking capacity I ₁ to I ₅ (8.5.5)	N

ВРЕМЯ С
ОПЫТАНИА

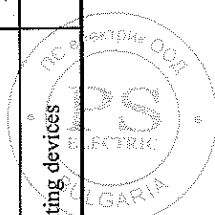

[Handwritten signature]

19

Clause	Test sequence	Sample No	R _i mΩ	Test-voltage V (AC)	Test-current kA	cos φ	Making angle after voltage zero (U ₀)	i _b kA	i _s kA	Peak arc voltage V	Initiation of arcing after voltage zero (U ₀)	Pre-arcing time ms	Operating time ms	Pre-arcing I ² t A ² s	Operating I ² t A ² s	Osz No	Result-Remark	
8.5 No	Breaking capacity (I ₁)	11	55,0	558	125	0,16	84	0,802		1104	85	0,03	0,04			27DS041	Resistance between fuse-link contacts measured after each test. Test voltage DC 500 V Verdict Remark ∞ MΩ	
		12	54,5	558	125	0,16	83	0,591		1104	84	0,03	0,04			27DS042	∞ MΩ	
		13	54,0	558	125	0,16	46	0,627		1100	46	0,01	0,04			27DS043	∞ MΩ	
8.5 No 2	Breaking capacity (I ₂)	14	52,5	552	0,124	0,26	0		0,122	2416	69	3,90	6,67			98527	∞ MΩ	
		15	52,2	560	0,124	0,26	0		0,121	2404	69	3,87	6,87			98528	∞ MΩ	
		16	52,0	552	0,124	0,26	1		0,121	2528	72	3,97	6,70			98529	∞ MΩ	
8.5 No 3	Breaking capacity (I ₃)	17	52,0	552	0,026	0,38						0,037 s					∞ MΩ	
8.5 No 4	Breaking capacity (I ₄)	18	52,5	560	0,020	0,40						0,070 s					∞ MΩ	
8.5 No 5	Breaking capacity (I ₅)	19	52,0	556	0,012	0,41						0,480 s					∞ MΩ	
8.7.4	Overcurrent discrimination(I ² t-Wert)	20	53,8	288	0,034	0,29	3							19,27			98648	∞ MΩ
		21	54,0	288	0,034	0,29	1							17,66			98649	∞ MΩ
		22	50,0	328	0,130	0,27	5							24,91			98661	∞ MΩ
8.9.2	Resistance to heat	23	53,3	328	0,130	0,27	4									98662	∞ MΩ	
8.11.1.8	Impact resistance			Gripping-lugs; to 80°C; 2h) then loaded with 150% rated current; tensile force F _{max} (Table J)N														
8.11.2.2	Resistance to abnormal heat and fire			Gripping-lugs; the facility is given in Fig. 9; 168h to 150°C; the weight 300 g; the height 300 mm														
8.11.2.4	Non-deterioration of insulating parts of fuse-link and fuse-base			Gripping-lugs; the facility is given in Fig. 9; 72h to -15°C; the weight 300 g; the height 300 mm														
				parts of insulating materials; glow-wire 960°C; to item a) of sub-clause 8.11.2.2.5														
				parts of insulating materials; glow-wire 650°C; to item b) of sub-clause 8.11.2.2.5														
				for equipment comprising moulded elements intended to support live parts; 150°C; 168h; Breaking capacity (I ₁) to Table 12A														
				for equipment comprising moulded elements intended to support live parts; 150°C; 168h; Breaking capacity (I ₁) to Table 12A														
				for equipment comprising moulded elements intended to support live parts; 150°C; 168h; Breaking capacity (I ₂) to Table 12A														

20

[Handwritten signature]

EZU Testing and Certification Institute

Type of fuse: **HRC-fuse**; Type **PV10 gG**; **4A**; **AC 500V**; **Size 10x38**
 Made by: **OEZ Letohrad s.r.o.**
 Tests according
 IEC 60269-1:98 3rd ed.+ Amd1:05; IEC 60269-2: 2nd ed.+ Amd1:95+ Amd2:01;
 IEC 60269-2-1:04 4th ed. table 7A

CB
 Ref. No.: 702102-01/01
 Table No: 7A
 Checked by: J., Hlavaty
 Dated: 03.08.07

page - 9 / 78 -

Clause	Test sequence	Samples Nr	Requirement-Test	Deviations: Type: PV10 In = 4A				Result-Remark)	
				Prescribed (mm)	Samples Nr 1	Samples Nr 2	Samples Nr 3		Measured (mm)
8.1.4	Dimensions	1-3	Fig. I(III) Size 10 x 38						
				Dimension marking a	38 ± 0,6	37.5	37.5	37.5	P
				Dimension marking b	max 10,5	9.1	9.4	9.1	P
				Dimension marking c	10,3 ± 0,1	10.2	10.2	10.2	P
				Dimension marking d	min 6	10.2	10.2	10.2	P
				Dimension marking r	1,5 ± 0,5	1.2	1.2	1.2	P

Handwritten signature

Handwritten signature

БІРНО С
 ОПИТОВАНА

ПС
 ELECTRIC
 BULGARIA

Handwritten mark

EZU Testing and Certification Institute

Type of fuse: HRC-fuse ; Type PV10 gG ; 6A ; AC 500V ; Size 10x38
 Made by: OEZ Letohrad s.r.o.
 Tests according IEC 60269-1:98 3rd ed.+ Amd1:05; IEC 60269-2: 2nd ed.+ Amd1:95+ Amd2:01; table 7A
 IEC 60269-2-1:04 4th ed.

CB page - 10 / 78 -
 Ref. No.: 702102-01/01
 Table No: 7A
 Checked by: J. Hlavaty Dated:03.08.07

Clause	Test-sequence	Samp les No	R _i mΩ	Test-voltage V (AC)	Test-current A	cos φ	Pre-arcing time s	Operating time s	Requirement-Test	Result-Remark verdict
6	Marking	1							The marking of the rated voltage/rated current /size discernible from the front	P see page 34
8.1.4	Dimension	1-3							Fig. I(III) Size 10 x 38	P see page 12
8.1.5.1	Resistance (R _i)	1-23							Measuring current ≤ 0,1 I _n ; Ambient air temperature 20 ± 5°C	P see page 10, 11
8.3	Power dissipation (P _n) / temperature rise (ΔT)	1	23,3	10	6	-			Tab. M and Fig. I(III) (60269-2-1), P _n = max 3 W, Ambient air temperature: 20°C; Conventional time 1 h	P P _n = 0,88W ΔT = 13K
8.4.3.1a)	Conv. non-fusing current (I _{np})	1	23,3	10	9	-		> 3600	not operate within the conventional time 1h	P
8.4.3.1b)	Conv. fusing current (I _f)	2	19,0	10	11,4	-		780	operate within the conventional time 1 h	P
8.4.3.2	Rated current	3	20,0	10	9	-		> 3600	100 h pulse test; test current 1,05 x I _n 6,3A ; on 1 h/ off 0,1 x 1h, after the test conventional non-fusing current (I _{np}) 9 A; conventional time 1h	P
8.4.3.3.1	Gate a) I _{min} (10 s)	4	19,0	10	11	-	>4200		Testing current of Table 3, column 2; operating time > 10 s	P
	b) I _{max} (5 s)	5	19,0	200	28	-	0,86		operate within ≤ 5 s	P
	c) I _{min} (0,1 s)	6	19,2	200	26	-	1,18		operate within > 0,1 s	P
	d) I _{max} (0,1 s)	7	19,3	200	72	-	0,015		operate within ≤ 0,1 s	P
8.4.3.4	Overload	8	19,3	10	16,0	-	40		50 pulses; test current equal to 0,8 x 20 A stated for a pre-arcing time of 5 s	P
		9	19,7	10	16,0	-	38		on - 5 s / off - 0,2 x 1 h of the conventional time; current 16,0 A equal to	P
		10	19,8	10	16,0	-	42		current for the overload test; pre-arcing time of sample lies within stated zone	P
8.4.3.6	Indicating devices	-	-						Operation of indicating device verified in combination with the verification of breaking capacity I ₁ to I ₅ (8.5.5)	N

ВЪТРИНО С
ОРИГИНАЛ



Handwritten signature

Clause	Test sequence	Sample No	R _i mΩ	Test-voltage V (AC)	Test-current kA	cos φ	Making angle after voltage zero (U ₀)	i _b kA	i _s kA	Peak arc voltage V	Initiation of arcing after voltage zero (U ₀)	Pre-arcing time ms	Operating time ms	Pre-arcing I _t A ² s	Operating I _t A ² s	OsZ No	Result-Remark	
8.5 No	Breaking capacity (I ₁)	11	19,3	558	125	0,16	46	1,592		803	46	0,01	4,60			27DS038	P ∞ MΩ	
		12	19,3	558	125	0,16	84	1,859		1167	85	0,03	2,74			27DS039	P ∞ MΩ	
		13	19,5	558	125	0,16	84	1,788		929	84	0,02	2,42			27DS040	P ∞ MΩ	
		14	19,7	552	0,210	0,27	1		0,209	1408	73	4,13	8,80			98519	P ∞ MΩ	
		15	19,7	552	0,210	0,27	0		0,190	1400	71	4,00	8,90			98520	P ∞ MΩ	
		16	19,7	552	0,210	0,27	0		0,211	1272	70	3,93	9,23			98521	P ∞ MΩ	
8.5 No 3	Breaking capacity (I ₃)	17	19,3	552	0,036	0,37							0,191s				P ∞ MΩ	
		18	19,7	552	0,026	0,38							0,988 s				P ∞ MΩ	
8.5 No 4	Breaking capacity (I ₄)	19	19,3	552	0,015	0,4							43,3s				P ∞ MΩ	
		20	20,0	328	0,066	0,25	5					51,04				98653	P ∞ MΩ	
8.7.4	Overcurrent discrimination(I ² t- Wert)	21	20,8	328	0,066	0,25	7										98654	P ∞ MΩ
		22	18,8	328	0,221	0,23	8							72,02			98671	P ∞ MΩ
8.9.2	Resistance to heat	23	18,8	328	0,221	0,23	7										98672	P ∞ MΩ
																		N
8.11.1.8	Impact resistance																	N
8.11.2.2	Resistance to abnormal heat and fire																	N
8.11.2.4	Non-deterioration of insulating parts of fuse-link and fuse-base																	N
																		N

23

30

[Signature]

page - 12 / 78 -

EZU Testing and Certification Institute

Type of fuse: HRC-fuse ; Type PV10 gG ; 6A ; AC 500V ; Size 10x38
 Made by: OEZ Letohrad s.r.o.
 Tests according IEC 60269-1:98 3rd ed.+ Amd1:05; IEC 60269-2: 2nd ed.+ Amd1:95+ Amd2:01; table 7A
 IEC 60269-2-1:04 4th ed.

CB
 Ref. No.: 702102-01/01
 Table No: 7A
 Checked by: J. Hlavaty
 Dated:03.08.07

Clause	Test sequence	Samples Nr	Requirement-Test	Deviations: Type: PV10 In = 6A			Result-Remark)		
				Prescribed (mm)	Measured (mm)	Verdict			
8.1.4	Dimensions	1-3	Fig. 1(III) Size 10 x 38						
				Dimension marking a	38 ± 0,6	Samples Nr 1 37.6	Samples Nr 2 37.5	Samples Nr 3 37.7	P
				Dimension marking b	max 10,5	9.2	9.4	9.1	P
				Dimension marking c	10,3 ± 0,1	10.2	10.3	10.2	P
				Dimension marking d	min 6	10.2	10.3	10.2	P
				Dimension marking r	1,5 ± 0,5	1.2	1.2	1.3	P

Handwritten signature

БУЛГО С
 ОПИТИВАНА

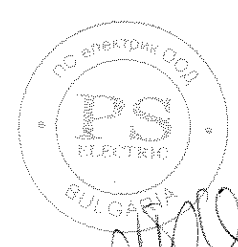

Handwritten signature

Handwritten signature

24

page - 13 / 78 -

CB
Ref. No.: 702102-01/01
Table No: 7B
Checked by: J., Hlavaty **Dated: 03.08.07**

Table 7B

Type of fuse: **HRC-fuse ; Type PV10 gG ; 8A ; AC 500V ; Size 10x38**
 Made by: **OEZ Letohrad s.r.o.**
 Tests according
 IEC 60269-1:98 3rd ed.+ Amd1:05; IEC 60269-2: 2nd ed.+ Amd1:95+ Amd2:01;
 IEC 60269-2-1:04 4th ed.

Clause	Test-sequence	Samp les No	R _i mΩ	Test-voltage V (AC)	Test current A	cos φ	Pre-arcing time s	Operating time s	Requirement-Test	Result-Remark verdict
6	Marking	1							The marking of the rated voltage/rated current /size discernible from the front	P see page 34
8.1.4	Dimension	1-3							Fig. 1(III) Size 10 x 38	P see page 15
8.1.5.1	Resistance (R _i)	1-23							Measuring current ≤ 0,1 I _n ; Ambient air temperature 20 ± 5°C	P see page 13, 14
8.3	Power dissipation (P _n) / temperature rise (ΔT)	1	13,6	10	8,0	-			Tab. M and Fig. 1(III) (60269-2-1), P _n = max 3 W, Ambient air temperature: 20°C; Conventional time 1 h	P P _n = 1,04W ΔT = 18K
8.4.3.1a)	Conv. non-fusing current (I _{nf})	1	13,6	10	12,0	-		> 3600	not operate within the conventional time 1h	P
8.4.3.1b)	Conv. fusing current (I _f)	2	12,5	10	15,2	-		840	operate within the conventional time 1.h	P
8.4.3.2	Rated current	3	13,1	10	12	-		> 3600	100 h pulse test; test current 1,05 × I _n 8,44A ; on 1 h/off 0,1 x 1h, after the test conventional non-fusing current (I _{nf}) 12 A; conventional time 1h	P
8.4.3.3.1	Gate a) I _{min} (10 s)	4	12,8	10	16,0	-	600		Testing current of Table 3, column 2; operating time > 10 s	P
	b) I _{max} (5 s)	5	12,9	200	35,2	-	1,91		operate within ≤ 5 s	P
	c) I _{min} (0,1 s)	6	13,0	200	41,6	-	0,61		operate within > 0,1 s	P
	d) I _{max} (0,1 s)	7	12,8	200	92,0	-	0,013		operate within ≤ 0,1 s	P
8.4.3.4	Overload	8	12,8	10	25,0	-	20		50 pulses; test current equal to 0,8 x 31 A stated for a pre-arcing time of 5 s	P
		9	13,3	10	25,0	-	18		on - 5 s / off - 0,2 x 1 h of the conventional time; current 25 A equal to	P
		10	13,5	10	25,0	-	24		current for the overload test; pre-arcing time of sample lies within stated zone	P
8.4.3.6	Indicating devices	-	-						Operation of indicating device verified in combination with the verification of breaking capacity I ₁ to I ₅ (8.5.5)	N

ВІСНОК
ОРИГІНАЛ

PS
ІНСТІТУТ



25

page - 14 / 78 -

CB
 Ref. No.: 702102-01/01
 Table No: 7B
 Checked by: J., Hlavaty
 Dated: 03.08.07

Type of fuse: HRC-fuse; Type PV10 gG; 8A; AC 500V; Size 10x38
 Made by: OEZ Letohrad s.r.o.
 Tests according
 IEC 60269-1-98 3rd ed.+ Amd1-05; IEC 60269-2: 2nd ed.+ Amd1-95+ Amd2-01;
 IEC 60269-2-1:04 4th ed.

table 7B

Clause	Test sequence	Sample No	R _i mΩ	Test-voltage V (AC)	Test-current kA	cos φ	Making angle after voltage zero (U ₀)	i _p kA	i _s kA	Peak arc voltage V	Initiation of arcing after voltage zero (U ₀)	Pre-arcing time ms	Operating time ms	Pre-arcing I ² t A ² s	Operating I ² t A ² s	Osz No	Result-Remark	
																	Resistance between fuse-link contacts measured after each test. Test voltage DC 500 V	Verdict Remark
8.5 No 1	Breaking capacity (I _b)	11	13,3	562	125	0,16	84	2,059		1217	85	0,04	2,77			27DS035	P	∞ MΩ
		12	13,3	558	125	0,16	83	2,059		1217	84	0,04	2,11			27DS036	P	∞ MΩ
		13	13,4	558	125	0,16	46	1,392		1029	46	0,01	3,89			27DS037	P	∞ MΩ
8.7.4	Overcurrent discrimination (I ² t-Wert)	14	13,5	328	0,096	0,23	4							69,63		98658	P	∞ MΩ
		15	13,6	328	0,096	0,23	0							69,99		98659	P	∞ MΩ
		16	12,6	328	0,315	0,24	4								93,50	98679	P	∞ MΩ
		17	12,6	328	0,315	0,24	10								96,98	98680	P	∞ MΩ

Handwritten signature

Handwritten signature

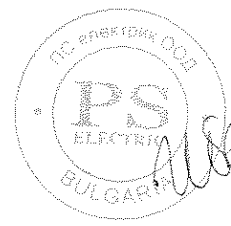

БУРНО С
 ОПИТИВАНА

Handwritten initials

page - 15 / 78 -

CB
Ref. No.: 702102-01/01
Table No: 7B
Checked by: J., Hlavaty
Dated: 03.08.07

EZU Testing and Certification Institute

Type of fuse: HRC-fuse ; Type PV10 gG ; 8A ; AC 500V ; Size 10x38
 Made by: OEZ Letohrad s.r.o.
 Tests according
 IEC 60269-1:98 3rd ed.+ Amd1:05; IEC 60269-2: 2nd ed.+ Amd1:95+ Amd2:01;
 IEC 60269-2-1:04 4th ed. table 7B

Clause	Test sequence	Samples Nr	Requirement-Test	Deviations: Type: PV10 In = 8A			Result-Remark)
				Prescribed (mm)	Measured (mm)	Verdict	
8.1.4	Dimensions	1-3	Fig. 1(III) Size 10 x 38				
				Dimension marking a	37.6	37.7	P
				Dimension marking b	9.2	9.1	P
				Dimension marking c	10.2	10.3	P
				Dimension marking d	10.2	10.3	P
				Dimension marking r	1.2	1.3	P

[Handwritten signature]

[Handwritten signature]

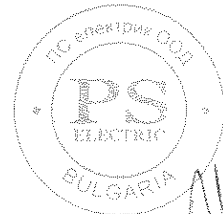

ВАРНО С
ОРИГИНАЛ

[Handwritten signature]

[Handwritten signature]

Type of fuse: HRC-fuse ; Type PV10 gG ; 10A ; AC 500V ; Size 10x38
 Made by: OEZ Letohrad s.r.o.
 Tests according
 IEC 60269-1:98 3rd ed.+ Amd1:05; IEC 60269-2: 2nd ed.+ Amd1:95+ Amd2:01;
 IEC 60269-2-1-04 4th ed. table 7C

CB page - 16 / 78 -
 Ref. No.: 702102-01/01
 Table No: 7C
 Checked by: J., Hlavaty Dated: 03.08.07

Clause	Test-sequence	Samplings No	R _i mΩ	Test-voltage V (AC)	Test-current A	cos φ	Pre-arcing time s	Operating time s	Requirement-Test	Result-Remark verdict
6	Marking	1							The marking of the rated voltage/rated current /size discernible from the front	P see page 34
8.1.4	Dimension	1-3							Fig. 1(III) Size 10 x 38	P see page 18
8.1.5.1	Resistance (R _i)	1-11							Measuring current ≤ 0,1 I _n ; Ambient air temperature 20 ± 5°C	P see page 16, 17
8.3	Power dissipation (P _n) / temperature rise (ΔT)	1	10,4	10	10	-			Tab. M and Fig. 1(III) (60269-2-1), P _n = max 3 W, Ambient air temperature: 20°C; Conventional time 1 h	P P _n = 1,29W ΔT = 20K
8.4.3.1a)	Conv. non-fusing current (I _{np})	1	10,4	10	15	-		> 3600	not operate within the conventional time 1h	P
8.4.3.1b)	Conv. fusing current (I _f)	2	9,45	10	19	-		600	operate within the conventional time 1 h	P
8.4.3.2	Rated current	3	10,2	10	15	-		> 3600	100 h pulse test; test current 1,05 x I _n 10,5A; on 1 h/ off 0,1 x 1h, after the test conventional non-fusing current (I _{np}) 15 A; conventional time 1h	P
8.4.3.3.1	Gate a) I _{min} (10 s)	4	9,80	10	22	-	208		Testing current of Table 3, column 2; operating time > 10 s	P
	b) I _{max} (5 s)	5	9,90	200	46	-	0,83		operate within ≤ 5 s	P
	c) I _{min} (0,1 s)	6	9,75	200	58	-	0,22		operating time > 0,1 s	P
	d) I _{max} (0,1 s)	7	9,75	200	110	-	0,023		operate within ≤ 0,1 s	P

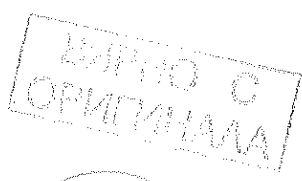
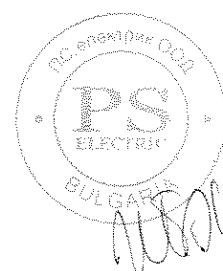

[Handwritten signature]

[Handwritten initials]

Type of fuse: HRC-fuse ; Type PV10 gG ; 10A ; AC 500V ; Size 10x38
 Made by: OEZ Letohrad s.r.o.
 Tests according
 IEC 60269-1:98 3rd ed.+ Amd1:05; IEC 60269-2: 2nd ed.+ Amd1:95+ Amd2:01;
 IEC 60269-2-1:04 4th ed. table 7C

CB Ref. No.: 702102-01/01 page - 17 / 78 -
 Table No: 7C
 Checked by: J. Hlavaty Dated:03.08.07

Clause	Test sequence	Sample No	R _i mΩ	Test-voltage V (AC)	Test-current kA	cos φ	Making angle after voltage zero (U ₀)	i _p kA	i _s kA	Peak arc voltage V	Initiation of arcing after voltage zero (U ₀)	Pre-arcing time ms	Operating time ms	Pre-arcing I ² t A ² s	Operating I ² t A ² s	OsZ No	Result-Remark
8.7.4	Overcurrent discrimination(I ² t-Wert)	8	10,4	328	0,130	0,27	3							121,86		98663	Resistance between fuse-link contacts measured after each test. Test voltage DC 500 V Verdict Remark
		9	10,4	328	0,130	0,27	2							123,57		98664	∞ MΩ
		10	9,60	328	0,404	0,25	8							175,38		98682	∞ MΩ
		11	9,65	320	0,404	0,25	7							178,13		98683	∞ MΩ

Handwritten signature

Handwritten signature



Handwritten number 29

Type of fuse: HRC-fuse ; Type PV10 gG ; 10A ; AC 500V ; Size 10x38
 Made by: OEZ Letohrad s.r.o.
 Tests according IEC 60269-1:98 3rd ed.+ Amd1:05; IEC 60269-2: 2nd ed.+ Amd1:95+ Amd2:01; table 7C
 IEC 60269-2-1:04 4th ed.

CB
 Ref. No.: 702102-01/01
 Table No: 7C
 Checked by: J. Hlavaty
 Dated: 03.08.07

page - 18 / 78 -

Clause	Test sequence	Samples Nr	Requirement-Test	Deviations: Type: PV10 In = 10A			Result-Remark)
				Prescribed (mm)	Measured (mm)	Verdict	
8.1.4	Dimensions	1-3	Fig. 1(III) Size 10 x 38				
				Samples Nr 1	Samples Nr 2	Samples Nr 3	
			Dimension marking a	37.6	37.6	37.7	P
			Dimension marking b	9.2	9.4	9.2	P
			Dimension marking c	10.2	10.3	10.2	P
			Dimension marking d	10.2	10.3	10.2	P
			Dimension marking r	1.2	1.2	1.3	P

Handwritten signature

Handwritten signature

ВЪНШНО С
ОРИГИНАЛ



30

EZU Testing and Certification Institute

Type of fuse: HRC-fuse ; Type PV10 gG ; I2A ; AC 500V ; Size 10x38

Made by: OEZ Letohrad s.r.o.

Tests according IEC 60269-1:98 3rd ed.+ Amd1:05; IEC 60269-2: 2nd ed.+ Amd1:95+ Amd2:01; IEC 60269-2-1:04 4th ed. table 7A

CB Ref. No.: 702102-01/01 page - 19 / 78 -
 Table No: 7A
 Checked by: J. Hlavaty Dated:03.08.07

Clause	Test-sequence	Samp les No	R _i mΩ	Test-voltage V (AC)	Test-current A	cos φ	Pre-arcing time s	Operating time s	Requirement-Test	Result-Remark verdict
6	Marking	1							The marking of the rated voltage/rated current /size discernible from the front	P see page 34
8.1.4	Dimension	1-3							Fig. 1(III) Size 10 x 38	P see page 21
8.1.5.1	Resistance (R _i)	1-23							Measuring current ≤ 0,1 I _n ; Ambient air temperature 20 ± 5°C	P see page 19, 20
8.3	Power dissipation (P _n) / temperature rise (ΔT)	1	8,04	10	12,0	-			Tab. M and Fig. 1(III) (60269-2-1), P _n = max 3 W, Ambient air temperature: 20°C; Conventional time 1 h	P P _n = 1,48k W ΔT = 23K
8.4.3.1a)	Conv. non-fusing current (I _{inf})	1	8,04	10	18,0	-		> 3600	not operate within the conventional time 1h	P
8.4.3.1b)	Conv. fusing current (I _f)	2	7,17	10	22,8	-		480	operate within the conventional time 1 h	P
8.4.3.2	Rated current	3	7,83	10	18	-		> 3600	100 h pulse test; test current 1,05 x I _n 12,6A ; on 1 h/off 0,1 x 1h, after the test conventional non-fusing current (I _{inf}) 18 A; conventional time 1h	P
8.4.3.3.1	Gate a) I _{min} (10 s)	4	7,54	10	24	-	193		Testing current of Table 3, column 2; operating time > 10 s	P
	b) I _{max} (5 s)	5	8,04	200	55,2	-	1,18		operate within ≤ 5 s	P
	c) I _{min} (0,1 s)	6	7,25	200	69,6	-	0,316		operating time > 0,1 s	P
	d) I _{max} (0,1 s)	7	7,71	200	140,4	-	0,021		operate within ≤ 0,1 s	P
8.4.3.4	Overload	8	7,33	10	36,0	-	22		50 pulses; test current equal to 0,8 x 45 A stated for a pre-arcing time of 5 s	P
		9	7,50	10	36,0	-	20		on - 5 s / off - 0,2 x 1 h of the conventional time; current 36 A equal to	P
		10	7,67	10	36,0	-	23		current for the overload test; pre-arcing time of sample lies within stated zone	P
8.4.3.6	Indicating devices	-	-						Operation of indicating device verified in combination with the verification of breaking capacity I ₁ to I ₅ (8.5.5)	N

ВЕРНО С ОПТИКАМА

PS ELECTRONIC BULGARIA

ЕЛЕКТРИК ООД

39

table 7A

Clause	Test sequence	Sample No	R _i mΩ	Test-voltage V (AC)	Test-current kA	cos φ	Making angle after voltage zero (U ₀)	i _b kA	i _s kA	Peak arc voltage V	Initiation of arcing after voltage zero (U ₀)	Pre-arcing time ms	Operating time ms	Pre-arcing I ² t A ² s	Operating I ² t A ² s	Os _z	Result-Remark		
8.5 No 1	Breaking capacity (I ₁)	11	7,33	558	125	0,16	48	2,647		1067	49	0,06	4,94			No	Resistance between fuse-link contacts measured after each test. Test voltage DC 500 V Resistance >1000 MΩ		
		12	7,33	558	125	0,16	86	3,039		1406	87	0,04	3,06					Verdict Remark	
		13	7,33	558	125	0,16	85	3,000		1343	86	0,04	3,18						
8.5 No 2	Breaking capacity (I ₂)	14	7,58	560	0,471	0,27	0		0,462	1520	62	3,47	8,63			98503			
		15	7,58	560	0,471	0,27	1		0,472	1544	61	3,50	8,47			98504			
		16	7,54	560	0,471	0,27	1		0,462	1504	59	3,37	8,57			98505			
8.5 No 3	Breaking capacity (I ₃)	17	7,83	552	0,074	0,4						0,231 s							
8.5 No 4	Breaking capacity (I ₄)	18	7,29	552	0,050	0,48						1,78 s							
8.5 No 5	Breaking capacity(I ₅)	19	7,29	556	0,032	0,38							30,4 s						
		20	7,88	328	0,175	0,26	5							220,17		98668			
		21	7,83	320	0,175	0,26	0								220,73		98669		
8.7.4	Overcurrent discrimination(I ² t-Wert)	22	7,21	328	0,451	0,25	11								316,63		98689		
		23	7,21	328	0,451	0,25	6								315,05		98690		
8.9.2	Resistance to heat																		
8.11.1.8	Impact resistance																		
8.11.2.2	Resistance to abnormal heat and fire																		
8.11.2.4	Non-deterioration of insulating parts of fuse-link and fuse-base																		

Gripping-lugs: to 80°C; 2h, then loaded with 150% rated current, tensile force F_{max} (Table J)N

Gripping-lugs: the facility is given in Fig. 9; 168h to 150°C; the weight 300 g; the height 300 mm

Gripping-lugs: the facility is given in Fig. 9; 72h to -15°C; the weight 300 g; the height 300 mm

parts of insulating materials; glow-wire 960°C; to item a) of sub-clause 8.11.2.2.5

parts of insulating materials; glow-wire 650°C; to item b) of sub-clause 8.11.2.2.5

for equipment comprising moulded elements intended to support live parts; 150°C; 168h; Breaking capacity (I₁) to Table 12A

for equipment comprising moulded elements intended to support live parts; 150°C; 168h; Breaking capacity (I₁) to Table 12A

for equipment comprising moulded elements intended to support live parts; 150°C; 168h; Breaking capacity (I₂) to Table 12A



EZU Testing and Certification Institute	Type of fuse: HRC-fuse ; Type PV10 gG ; I2A ; AC 500V ; Size 10x38 Made by: OEZ Letohrad s.r.o. Tests according IEC 60269-1:98 3 rd ed.+ Amd1:05; IEC 60269-2: 2 nd ed.+ Amd1:95+ Amd2:01; IEC 60269-2-1:04 4 th ed. table 7A	CB Ref. No.: 702102-01/01 Table No: 7A Checked by: J., Hlavaty Dated:03.08.07 page - 21 / 78 -
--	--	--

Clause	Test sequence	Samples Nr	Requirement-Test	Deviations: Type: PV10 In = 12A			Result-Remark)
				Prescribed (mm)	Samples Nr 1	Measured (mm)	
8.1.4	Dimensions	1-3	Fig. 1(III) Size 10 x 38				
					Samples Nr 2	Samples Nr 3	
			Dimension marking a	38 ± 0,6	37.6	37.6	P
			Dimension marking b	max 10,5	9.4	9.2	P
			Dimension marking c	10,3 ± 0,1	10.2	10.3	P
			Dimension marking d	min 6	10.2	10.3	P
			Dimension marking r	1,5 ± 0,5	1.2	1.3	P

MDS

[Signature]

ВЕРНО С
ОРИГИНАЛА

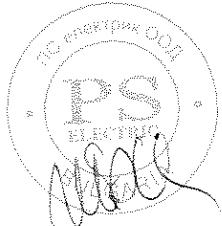

Type of fuse: HRC-fuse ; Type PV10 gG ; 16A ; AC 500V ; Size 10x38
 Made by: OEZ Letohrad s.r.o.
EZU Testing and Certification Institute
 Tests according IEC 60269-1:98 3rd ed.+ Amd1:05; IEC 60269-2: 2nd ed.+ Amd1:95+ Amd2:01; table 7B
 IEC 60269-2-1:04 4th ed.
 Ref. No.: 702102-01/01
 Table No: 7B
 Checked by: J., Hlavaty
 Dated:03.08.07
 page - 22 / 78 -

Clause	Test sequence	Samples Nr	R _i mΩ	Test-voltage V (AC)	Test-current A	cosp	Pre-arcing time s	Operating time s	Requirement-Test	Result-Remark	
										Verdict	
6	Marking	1							The marking of the rated voltage/rated current /size discernible from the front	P	see page 34
8.1.4	Dimension	1-3							Fig. 1(III) Size 10 x 38	P	see page 24
8.1.5.1	Resistance (R _t)	1-17							Measuring current ≤ 0,1 I _n ; Ambient air temperature 20 ± 5°C	P	see page 22, 23
8.3	Power dissipation (P _n) / temperature rise (ΔT)	1	5,69	10	16	-			Tab. M and Fig. 1(III) (60269-2-1), P _n = max 3 W, Ambient air temperature: 24°C; Conventional time 1 h	P	P _n = 1,86W ΔT = 25K
8.4.3.1a)	Conv. non-fusing current (I _{np})	1	5,69	10	20	-		> 3600	not operate within the conventional time 1 h	P	
8.4.3.1b)	Conv. fusing current (I _f)	2	5,25	10	25,6	-		780	operate within the conventional time 1 h	P	
8.4.3.2	Rated current	3	5,63	10	20	-		> 3600	100 h pulse test; test current 1,05 x I _{np} 16,8 A; on 1 h/ off 0,1 x 1 h, after the test conventional non-fusing current (I _{np}) 20A; conventional time 1 h	P	
8.4.3.3.2	Gate a) I _{min} (10 s)	4	5,47	10	33	-	87		Testing current of Table 3, column 2; operating time > 10 s	P	
	b) I _{max} (5 s)	5	5,44	200	65	-	2,05		operate within ≤ 5 s	P	
	c) I _{min} (0,1 s)	6	5,56	200	85	-	0,52		operating time > 0,1 s	P	
	d) I _{max} (0,1 s)	7	5,53	200	150	-	0,032		operate within ≤ 0,1 s	P	
8.4.3.4	Overload	8	5,38	10	46,0	-	15		50 pulses; test current equal to 0,8 x 57,0 A stated for a pre-arcing time of 5 s	P	
		9	5,38	10	46,0	-	14		on - 5 s / off - 0,2 x 1 h of the conventional time; current 46,0 A equal to	P	
		10	5,42	10	46,0	-	16		current for the overload test; pre-arcing time of sample lies within stated zone	P	
8.4.3.6	Indicating devices	-	-						Operation of indicating device verified in combination with the verification of breaking capacity I ₁ to I ₅ (8.5.5)	N	

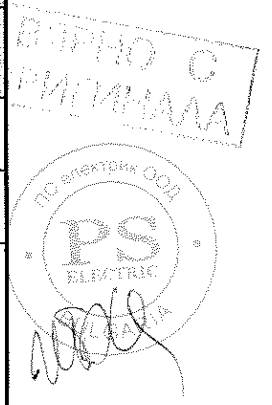

Handwritten initials: 24

EZU Testing and Certification Institute
 Type of fuse: HRC-fuse; Type PV10 gG; 16A; AC 500V; Size 10x38
 Made by: OEZ Letohrad s.r.o.
 Tests according IEC 60269-1:98 3rd ed.+ Amd1:05; IEC 60269-2: 2nd ed.+ Amd1:95+ Amd2:01; table 7B
 IEC 60269-2-1:04 4th ed.

CB Ref. No.: 702102-01/01 page - 23 / 78 -
 Table No: 7B
 Checked by: J. Hlavaty Dated: 03.08.07

Clause	Test sequence	Sample No	R _i mΩ	Test-voltage V (AC)	Test-current kA	cos φ	Making angle after voltage zero (U ₀)	i _b kA	i _s kA	Peak arc voltage V	Initiation of arcing after voltage zero (U ₀)	Pre-arcing time ms	Operating time ms	Pre-arcing I ² t A ² s	Operating I ² t A ² s	Osz No	Result-Remark	
																	Resistance between fuse-link contacts measured after each test. Test voltage DC 500 V	Resistance >1000 MΩ Verdict Remark
8.5 No 1	Breaking capacity (I ₁)	11	5,63	558	125	0,16	85	3,490		1368	86	0,06	3,51			27DS028	P	∞ MΩ
		12	5,63	558	125	0,16	86	3,608		1368	87	0,06	3,39			27DS029	P	∞ MΩ
		13	5,75	558	125	0,16	48	3,294		1104	49	0,08	5,19			27DS030	P	∞ MΩ
8.7.4	overcurrent discrimination (I ² t-Wert)	14	5,56	328	0,278	0,24	2							448,24		99982	P	∞ MΩ
		15	5,56	320	0,278	0,24	0							429,26		99983	P	∞ MΩ
		16	5,25	320	0,544	0,23	3								761,03	99977	P	∞ MΩ
		17	5,31	320	0,544	0,23	5								752,26	99978	P	∞ MΩ

Handwritten signature

Handwritten signature

ВАРНО С
 ОРИГИНАЛА



EZU Testing and Certification Institute	Type of fuse: HRC-fuse ; Type PV10 gG ; 16A ; AC 500V ; Size 10x38 Made by: OEZ Letohrad s.r.o. Tests according IEC 60269-1-98 3 rd ed.+ Amd1:05; IEC 60269-2: 2 nd ed.+ Amd1:95+ Amd2:01; IEC 60269-2-1:04 4 th ed. table 7B	CB Ref. No.: 702102-01/01 Table No: 7B Checked by: J. Hlavaty Dated:03.08.07 page - 24 / 78 -
--	---	--

Clause	Test sequence	Samples Nr	Requirement-Test	Deviations: Type: PV10 In = 16 A			Result-Remark)
				Prescribed (mm)	Measured (mm)	Verdict	
8.1.4	Dimensions	1-3	Fig. 1(III) Size 10 x 38				
				Samples Nr 1	Samples Nr 2	Samples Nr 3	
			Dimension marking a	37.6	37.5	37.6	P
			Dimension marking b	9.5	9.4	9.3	P
			Dimension marking c	10.2	10.3	10.2	P
			Dimension marking d	10.2	10.3	10.2	P
			Dimension marking r	1.2	1.2	1.3	P

Handwritten signature

Handwritten signature

ВЯРНО С
ОРИГИНАЛА



36

EZU Testing and Certification Institute

Type of fuse: HRC-fuse ; Type PV10 gG ; 20A ; AC 500V ; Size 10x38
 Made by: OEZ Letohrad s.r.o.
 Tests according IEC 60269-1:98 3rd ed.+ Amd1:05; IEC 60269-2: 2nd ed.+ Amd1:95+ Amd2:01; IEC 60269-2-1:04 4th ed. table 7A

CB Ref. No.: 702102-01/01 page - 25 / 78 -
 Table No: 7A
 Checked by: J. Hlavaty Dated:03.08.07

Clause	Test-sequence	Sam- ples No	R _i mΩ	Test- voltage V (AC)	Test current A	cos φ	Pre- arcing time s	Operating time s	Requirement-Test	Result-Remark verdict
6	Marking	1							The marking of the rated voltage/rated current /size discernible from the front	P see page 34
8.1.4	Dimension	1-3							Fig. 1(III) Size 10 x 38	P see page 27
8.1.5.1	Resistance (R _i)	1-23							Measuring current ≤ 0,1 I _n ; Ambient air temperature 20 ± 5°C	P see page 25, 26
8.3	Power dissipation (P _n) / / temperature rise (ΔT)	1	4,33	10	20	-			Tab. M and Fig. 1(III) (60269-2-1), P _n = max 3 W, Ambient air temperature: 24°C; Conventional time 1 h	P P _n = 2,2 W ΔT = 33K
8.4.3.1a)	Conv. non-fusing current (I _{np})	1	4,33	10	25	-		> 3600	not operate within the conventional time 1h	P
8.4.3.1b)	Conv. fusing current (I _f)	2	3,95	10	32	-		480	operate within the conventional time 1 h	P
8.4.3.2	Rated current	3	4,20	10	25	-		> 3600	100 h pulse test; test current 1,05 x I _n 21A ; on 1 h/ off 0,1 x 1h, after the test conventional non-fusing current (I _{np}) 25 A; conventional time 1h	P
8.4.3.3.1	Gate a) I _{min} (10 s)	4	4,18	10	42	-	56		Testing current of Table 3, column 2;	P
	b) I _{max} (5 s)	5	3,90	200	85	-	2,64		" " " 3, " 3 operate within ≤ 5 s	P
	c) I _{min} (0,1 s)	6	4,03	200	110	-	0,27		" " " 3, " 4 operating time > 0,1 s	P
	d) I _{max} (0,1 s)	7	4,05	200	200	-	0,038		" " " 3, " 5 operate within ≤ 0,1 s	P
8.4.3.4	Overload	8	4,00	10	56,0	-	15		50 pulses; test current equal to 0,8 x 70,0 A stated for a pre-arcing time of 5 s	P
		9	4,03	10	56,0	-	16		on - 5 s / off - 0,2 x 1 h of the conventional time; current 56,0 A equal to	P
		10	4,03	10	56,0	-	15		current for the overload test; pre-arcing time of sample lies within stated zone	P
8.4.3.6	Indicating devices	-	-						Operation of indicating device verified in combination with the verification of breaking capacity I ₁ to I ₅ (8.5.5)	N

(Handwritten signature)

ВАРНО С
ОРИГИНАЛ



37

Clause	Test sequence	Sample No	R _i mΩ	Test-voltage V (AC)	Test-current kA	cos φ	Making angle after voltage zero (U ₀)	i _p kA	i _s kA	Peak arc voltage V	Initiation of arcing after voltage zero (U ₀)	Pre-arcing time ms	Operating time ms	Pre-arcing I ² t A ² s	Operating I ² t A ² s	Osz No	Result-Remark		
																	Verdict	Remark	
8.5 No 1	Breaking capacity (I ₁)	11	3,90	558	125	0,16	48	4,157		1155	50	0,09	4,68			27DS025	P	∞ MΩ	
		12	3,90	558	125	0,16	87	4,628		1443	88	0,08	2,19			27DS026	P	∞ MΩ	
		13	3,95	558	125	0,16	85	4,588		1418	86	0,07	2,58			27DS027	P	∞ MΩ	
8.5 No 2	Breaking capacity (I ₂)	14	3,98	560	0,993	0,24	0		0,908	1384	68	3,80	7,70			99989	P	∞ MΩ	
		15	3,98	560	0,993	0,24	3		0,896	1328	68	3,63	7,37			99990	P	∞ MΩ	
		16	4,00	560	0,993	0,24	4		0,900	1272	69	3,63	7,70			99991	P	∞ MΩ	
8.5 No 3	Breaking capacity (I ₃)	17	4,03	560	0,117	0,43						0,221 s				P	∞ MΩ		
8.5 No 4	Breaking capacity (I ₄)	18	4,10	552	0,075	0,4						1,54 s				P	∞ MΩ		
8.5 No 5	Breaking capacity (I ₅)	19	4,18	558	0,044	0,38							59,3 s				P	∞ MΩ	
		20	4,00	320	0,408	0,24	1					740,98			99980	P	∞ MΩ		
		21	4,03	320	0,408	0,24	4				748,83			99981	P	∞ MΩ			
8.7.4	Overcurrent discrimination (I ² t-Wert)	22	3,95	344	0,793	0,28	6							1263,84	99972	P	∞ MΩ		
		23	4,00	336	0,793	0,28	5							1236,53	99973	P	∞ MΩ		
8.9.2	Resistance to heat																N		
8.11.1.8	Impact resistance																	N	
																		N	
																		N	
8.11.2.2	Resistance to abnormal heat and fire																	N	
																		N	
8.11.2.4	Non-deterioration of insulating parts of fuse-link and fuse-base																	N	
																		N	

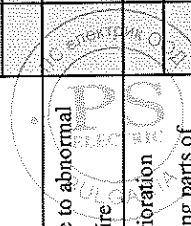

Handwritten signature and initials.

EZU Testing and Certification Institute

Type of fuse: HRC-fuse ; Type PV10 gG ; 20A ; AC 500V ; Size 10x38
 Made by: OEZ Letohrad s.r.o.
 Tests according IEC 60269-1:98 3rd ed.+ Amd1:05; IEC 60269-2: 2nd ed.+ Amd1:95+ Amd2:01; IEC 60269-2-1:04 4th ed. table 7A

CB Ref. No.: 702102-01/01
 Table No: 7A
 Checked by: J. Hlavaty Dated:03.08.07
 page - 27 / 78 -

Clause	Test sequence	Samples Nr	Requirement-Test	Deviations: Type: PV10 In = 20 A			Result-Remark)		
				Prescribed (mm)	Measured (mm)	Verdict			
8.1.4	Dimensions	1-3	Fig. 1(III) Size 10 x 38						
				Dimension marking a	38 ± 0,6	Samples Nr 1 37.6	Samples Nr 2 37.5	Samples Nr 3 37.6	P
				Dimension marking b	max 10,5	9.5	9.4	9.3	P
				Dimension marking c	10,3 ± 0,1	10.2	10.3	10.2	P
				Dimension marking d	min 6	10.2	10.3	10.2	P
				Dimension marking r	1,5 ± 0,5	1.2	1.2	1.3	P

Handwritten signature

Handwritten signature

ВАЖНО С
ОРИГИНАЛА

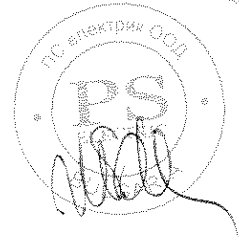

EZU Testing and Certification Institute	Type of fuse: HRC-fuse ; Type PV10 gG ; 25A ; AC 500V ; Size 10x38 Made by: OEZ Letohrad s.r.o. Tests according IEC 60269-1:98 3 rd ed.+ Amd1:05; IEC 60269-2: 2 nd ed.+ Amd1:95+ Amd2:01; IEC 60269-2-1:04 4 th ed.	CB Ref. No.: 702102-01/01 Table No: 7A Checked by: J. Hlavatý Dated: 03.08.07	page - 28 / 78 -
	table 7A		

Clause	Test sequence	Samp les	R _i	Test-voltage V (AC)	Test-current A	cosφ	Pre-arcing time s	Operating time s	Requirement-Test	Result-Remark)
6	Marking	Nr							The marking of the rated voltage/rated current /size discernible from the front	Verdict P see page 34
8.1.4	Dimension	1-3							Fig. 1(III) Size 10 x 38	P see page 30
8.1.5.1	Resistance (R _i)	1-20							Measuring current ≤ 0,1 I _n ; Ambient air temperature 20 ± 5°C	P see page 28, 29
8.3	Power dissipation (P _n)/ /temperature rise (ΔT)	1	3,14	10	25	-			Tab. M and Fig. 1(III) (60269-2-1), P _n = max 3 W, Ambient air temperature: 24°C; Conventional time 1 h	P P _n = 2,58W ΔT = 33K
8.4.3.1a)	Conv. non-fusing current (I _{inf})	1	3,14	10	31,25	-		> 3600	not operate within the conventional time 1 h	P
8.4.3.1b)	Conv. fusing current (I _f)	2	2,9	10	40	-		1620	operate within the conventional time 1 h	P
8.4.3.2	Rated current	3	3,60	10	31,25	-		> 3600	100 h pulse test; test current 1,05 x I _n , 26,25 A; on 1 h/ off 0,1 x 1 h, after the test conventional non-fusing current (I _{inf}) 31,25; conventional time 1 h	P
8.4.3.3.2	Gate a) I _{min} (10 s)	4	3,18	10	52	-	117		Testing current of Table 3, column 2; operating time > 10 s	P
	b) I _{max} (5 s)	5	3,06	200	110	-	2,86		operate within ≤ 5 s	P
	c) I _{min} (0,1 s)	6	3,02	200	150	-	0,7		operate within > 0,1 s	P
	d) I _{max} (0,1 s)	7	3,02	200	260	-	0,037		operate within ≤ 0,1 s	P
8.4.3.4	Overload	8	2,96	10	78,0	-	16		50 pulses; test current equal to 0,8 x 98,0 A stated for a pre-arcing time of 5 s	P
		9	3,00	10	78,0	-	15		on 5 s/off - 0,2 x 1 h of the conventional time; current 78,0A equal to	P
		10	3,04	10	78,0	-	18		current for the overload test; pre-arcing time of sample lies within stated zone	P
8.4.3.5	Conventional cable overload protection	11	3,08	10	37,7	-		1560	conductors of cross-sectional areas 2,5 mm ² ; preheated with test current I _n (25 A); time. 1 h equal to the conv. time;	P
		12	3,10	10	37,7	-		1320	test current increased 1,45 x I _z 37,7 A; samples operated within the conv. time (1 h)	P
		13	3,12	10	37,7	-		1140	Operation of indicating device verified in combination with the verification of breaking capacity I ₁ to I ₅ (8.5.5)	P
8.4.3.6	Indicating devices	-	-							N

40

Clause	Test sequence	Sample No	R _i mΩ	Test-voltage V (AC)	Test-current kA	cos φ	Making angle after voltage zero (U ₀)	i _D kA	i _S kA	Peak arc voltage V	Initiation of arcing after voltage zero (U ₀)	Pre-arcing time ms	Operating time ms	Pre-arcing I ² t A ² s	Operating I ² t A ² s	OsZ No	Result-Remark
8.5 No 1	Breaking capacity (I ₁)	14	3,08	558	125	0,16	76	5,333		1368	77	0,08	2,71			27DS022	Resistance between fuse-link contacts measured after each test. Test voltage DC 500 V
		15	3,08	558	125	0,16	90	5,490		1418	92	0,09	2,23			27DS023	Verdict
		16	3,08	558	125	0,16	50	4,902		1117	52	0,12	4,27			27DS024	∞ MΩ
8.5 No 2	Breaking capacity (I ₂)	17	2,92	552	1,260	0,27	5		1,216	1376	72	3,73	7,27			1604	∞ MΩ
		18	2,92	552	1,260	0,27	3		1,184	1400	70	3,73	7,43			1605	∞ MΩ
		19	2,98	552	1,260	0,27	3		1,200	1368	68	3,67	7,17			1606	∞ MΩ
8.5 No 3	Breaking capacity (I ₃)	20	3,02	560	0,145	0,48						0,595 s					∞ MΩ
8.5 No 4	Breaking capacity (I ₄)	21	3,02	552	0,093	0,43						5,66 s					∞ MΩ
8.5 No 5	Breaking capacity (I ₅)	22	2,98	556	0,058	0,41						104 s					∞ MΩ
8.7.4	Overcurrent discrimination (I ² t-Wert)	23	3,04	328	0,544	0,23	4							1399,3		99975	∞ MΩ
		24	3,04	320	0,544	0,23	1							1255,4		99976	∞ MΩ
		25	2,96	344	1,010	0,26	5								1967,3	99964	∞ MΩ
8.9.2	Resistance to heat	26	2,96	344	1,010	0,26	8								1986,9	99965	∞ MΩ
8.11.1.8	Impact resistance																N
8.11.2.2	Resistance to abnormal heat and fire																N
8.11.2.4	Non-deterioration of insulating parts of fuse-link and fuse-base																N
																	N

Gripping-lugs; to 80°C; 2h, then loaded with 150%-rated current; tensile force F_{max} (Table J)N
 Gripping-lugs; the facility is given in Fig. 9; 168h to 150°C; the weight 300 g; the height 300 mm
 Gripping-lugs; the facility is given in Fig. 9; 72h to -15°C; the weight 300 g; the height 300 mm
 parts of insulating materials; glow-wire 960°C; to item a) of sub-clause 8.11.2.2.5
 parts of insulating materials; glow-wire 650°C; to item b) of sub-clause 8.11.2.2.5
 for equipment comprising moulded elements intended to support live parts; 150°C; 168h; Breaking capacity (I₁) to Table 12A
 for equipment comprising moulded elements intended to support live parts; 150°C; 168h; Breaking capacity (I₁) to Table 12A
 for equipment comprising moulded elements intended to support live parts; 150°C; 168h; Breaking capacity (I₂) to Table 12A



EZU Testing and Certification Institute Type of fuse: **HRC-fuse ; Type PV10 gG ; 25A ; AC 500V ; Size 10x38** page - 30 / 78 -
 Made by: **OEZ Letohrad s.r.o.** Tests according Ref. No.: **702102-01/01** CB
 IEC 60269-1:98 3rd ed.+ Amd1:05; IEC 60269-2: 2nd ed.+ Amd1:95+ Amd2:01; Table No: **7A** Dated: **03.08.07**
 IEC 60269-2-1:04 4th ed. table 7A Checked by: **J., Hlavaty**

Clause	Test sequence	Samples Nr	Requirement-Test	Deviations: Type: <i>PV10</i> In = 25A				Result-Remark)	
				Prescribed (mm)	Samples Nr 1	Samples Nr 2	Samples Nr 3		Measured (mm)
8.1.4	Dimensions	1-3	Fig. 1(III) Size 10 x 38						
				Dimension marking a	38 ± 0,6	37.6	37.7	37.4	P
				Dimension marking b	max 10,5	9.3	9.4	9.7	P
				Dimension marking c	10,3 ± 0,1	10.3	10.3	10.2	P
				Dimension marking d	min 6	10.3	10.3	10.2	P
				Dimension marking r	1,5 ± 0,5	1.3	1.2	1.3	P

Handwritten signature

Handwritten signature



ВАРНО С
ОРИГИНАЛА

Handwritten initials

EZU Testing and Certification Institute

Type of fuse: **HRC-fuse ; Type PV10 gG ; 32A ; AC 500V ; Size 10x38**
 Made by: **OEZ Letohrad s.r.o.**
 Tests according
 IEC 60269-1:98 3rd ed.+ Amd1:05; IEC 60269-2: 2nd ed.+ Amd1:95+ Amd2:01;
 IEC 60269-2-1:04 4th ed. **table 7A**

page - 31 / 78 -
 Ref. No.: 702102-01/01
 Table No: 7A
 Checked by: **J. Hlavaty** Dated: 03.08.07

Clause	Test-sequence	Samp les No	R _i mΩ	Test-voltage V (AC)	Test current A	cos φ	Pre- arcing time s	Operating time s	Requirement-Test	Result-Remark verdict
6	Marking	1							The marking of the rated voltage/rated current /size discernible from the front	P see page 34
8.1.4	Dimension	1-3							Fig. 1(III) Size 10 x 38	P see page 33
8.1.5.1	Resistance (R _i)	1-26							Measuring current ≤ 0,1 I _n ; Ambient air temperature 20 ± 5°C	P see page 31, 32
8.3	Power dissipation (P _n) / temperature rise (ΔT)	1	1,97	10	32	-			Tab. M and Fig. 1(III) (60269-2-1), P _n = max 3 W, Ambient air temperature: 24°C; Conventional time 1 h	P P _n = 2,54 W ΔT = 36K
8.4.3.1a)	Conv. non-fusing current (I _{nf})	1	1,97	10	40	-		> 3600	not operate within the conventional time 1h	P
8.4.3.1b)	Conv. fusing current (I _f)	2	1,86	10	51,2	-		1560	operate within the conventional time 1.h	P
8.4.3.2	Rated current	3	1,88	10	40	-		> 3600	100 h pulse test; test current 1,05 x I _n 33,6A; on 1 h/off 0,1 x 1h, after the test conventional non-fusing current (I _{nf}) 40 A; conventional time 1h	P
8.4.3.3.1	Gate a) I _{min} (10 s)	4	1,94	10	75	-	84		Testing current of Table 3, column 2; operating time > 10 s	P
	b) I _{max} (5 s)	5	1,91	200	150	-	3,0		operate within ≤ 5 s	P
	c) I _{min} (0,1 s)	6	2,13	200	200	-	0,58		operating time > 0,1 s	P
	d) I _{max} (0,1 s)	7	1,92	200	350	-	0,067		operate within ≤ 0,1 s	P
8.4.3.4	Overload	8	1,91	10	104	-	17		50 pulses; test current equal to 0,8 x I ₃₀ A stated for a pre-arcing time of 5 s	P
		9	1,92	10	104	-	18		on - 5(s / off - 0,2 x 1 h of the conventional time; current 104A equal to	P
		10	1,92	10	104	-	15		current for the overload test; pre-arcing time of sample lies within stated zone	P
8.4.3.5	Conventional cable overload protection	11	1,97	10	50,75	-		900	conductors of cross-sectional areas 4 mm ² ; preheated with test current I _n (32 A); time. 1 h equal to the conv. time;	P
		12	1,95	10	50,75	-		1020	test current increased 1,45 x I _n 50,75 A; samples operated within the conv. time (1 h)	P
		13	1,94	10	50,75	-		780		P
8.4.3.6	Indicating devices	-							Operation of indicating device verified in combination with the verification of breaking capacity I ₁ to I ₅ (8.5.5)	N

[Handwritten Signature]

P O
TAMA



13

EZU Testing and Certification Institute

Type of fuse: HRC-fuse ; Type PV10 gG ; 32A ; AC 500V ; Size 10x38
 Made by: O EZ Letohrad s.r.o.
 Tests according IEC 60269-1:98 3rd ed.+ Amd1:05; IEC 60269-2: 2nd ed.+ Amd1:95+ Amd2:01;
 IEC 60269-2-1:04 4th ed. table 7A

CB Ref. No.: 702102-01/01
 Table No: 7A
 Checked by: J. Hlavaty

page - 32 / 78 -

Dated:03.08.07

Clause	Test sequence	Sample No	R _i mΩ	Test-voltage V (AC)	Test-current kA	cos φ	Making angle after voltage zero (U ₀)	i _b kA	i _s kA	Peak arc voltage V	Initiation of arcing after voltage zero (U ₀)	Pre-arcing time ms	Operating time ms	Pre-arcing I ² t A ² s	Operating I ² t A ² s	OsZ No	Result-Remark	
8.5 No 1	Breaking capacity (I ₁)	14	1,84	552	103	0,17	47	6,549		1355	50	0,18	3,73			22ES048	Resistance between fuse-link contacts measured after each test. Test voltage DC 500 V	
		15	1,88	555	103	0,17	84	7,137		1531	86	0,14	2,28			22ES049	∞ MΩ	
		16	1,88	555	103	0,17	83	7,216		1544	86	0,15	2,60			22ES051	∞ MΩ	
		17	1,91	552	1,722	0,29	5		1,808		1584		4,00	6,70		99997	∞ MΩ	
		18	1,91	552	1,722	0,29	0		1,792		1488		4,10	6,80		99998	∞ MΩ	
		19	1,91	552	1,722	0,29	5		1,728		1376		3,87	7,17		99999	∞ MΩ	
8.5 No 3	Breaking capacity (I ₃)	20	1,88	552	0,179	0,31							1,21 s				∞ MΩ	
		21	1,88	560	0,117	0,43							5,26 s				∞ MΩ	
8.5 No 4	Breaking capacity (L ₄)	22	1,89	554	0,075	0,40							108,6 s				∞ MΩ	
		23	1,95	344	0,793	0,28	5						3632,9		99970		∞ MΩ	
8.7.4	Overcurrent discrimination (I ² t-Wert)	24	1,95	344	0,793	0,28	2						3572,3		99971		∞ MΩ	
		25	1,89	328	1,220	0,28	6						4939,3		99961		∞ MΩ	
		26	1,88	320	1,220	0,28	0						4816,5		99962		∞ MΩ	
8.9.2	Resistance to heat																N	
8.11.1.8	Impact resistance																	N
																		N
8.11.2.2	Resistance to abnormal heat and fire																	N
																		N
8.11.2.4	Non-deterioration of insulating parts of fuse-link and fuse-base																	N
																		N

AA

EZU Testing and Certification Institute

Type of fuse: **HRC-fuse**; Type **PV10 gG**; **32A**; **AC 500V**; Size **10x38**
 Made by: **OEZ Letohrad s.r.o.**
 Tests according
 IEC 60269-1:98 3rd ed.+ Amd1:05; IEC 60269-2: 2nd ed.+ Amd1:95+ Amd2:01;
 IEC 60269-2-1:04 4th ed. table 7A

CB Ref. No.: 702102-01/01
 Table No: 7A
 Checked by: J., Hlavaty Dated:03.08.07

page - 33 / 78 -

Clause	Test sequence	Samples Nr	Requirement-Test	Deviations: Type: PV10 In = 32A				Result-Remark)
				Prescribed (mm)	Samples Nr 1	Samples Nr 2	Samples Nr 3	
8.1.4	Dimensions	1-3	Fig. 1(III) Size 10 x 38					
			Dimension marking a	38 ± 0,6	37.6	37.5	37.6	P
			Dimension marking b	max 10,5	9.3	9.6	9.5	P
			Dimension marking c	10,3 ± 0,1	10.2	10.3	10.3	P
			Dimension marking d	min 6	10.2	10.3	10.3	P
			Dimension marking r	1,5 ± 0,5	1.3	1.2	1.2	P

Handwritten signature

Handwritten signature

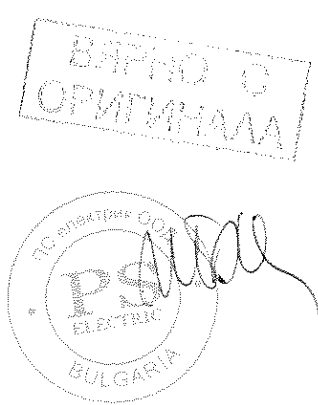

45

TEST REPORT

IEC 60269-1:98 3rd ed.+ Amd1:05; IEC 60269-2: 2nd ed.+ Amd1:95+ Amd2:01; IEC 60269-2-1:04 4th ed.

OEZ
10x38
PV10
2AgG
~ 500V
I_t 120 kA



Cd/Pb-free

OEZ
10x38
PV10
4AgG
~ 500V
I_t 120 kA



Cd/Pb-free

OEZ
10x38
PV10
6AgG
~ 500V
I_t 120 kA



Cd/Pb-free

OEZ
10x38
PV10
8AgG
~ 500V
I_t 120 kA



Cd/Pb-free

OEZ
10x38
PV10
10AgG
~ 500V
I_t 120 kA



Cd/Pb-free

OEZ
10x38
PV10
12AgG
~ 500V
I_t 120 kA



Cd/Pb-free

OEZ
10x38
PV10
16AgG
~ 500V
I_t 120 kA



Cd/Pb-free

OEZ
10x38
PV10
20AgG
~ 500V
I_t 120 kA



Cd/Pb-free

OEZ
10x38
PV10
25AgG
~ 500V
I_t 120 kA



Cd/Pb-free

OEZ
10x38
PV10
32AgG
~ 500V
I_t 100 kA



Cd/Pb-free

ВАЖНО С
ОФИЦИАЛНА

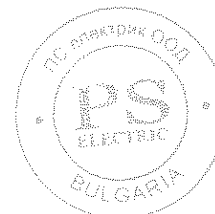

[Handwritten signature]

[Handwritten initials]

TEST REPORT

IEC 60269-1:98 3rd ed.+ Amd1:05; IEC 60269-2: 2nd ed.+ Amd1:95+ Amd2:01; IEC 60269-2-1:04 4th ed.

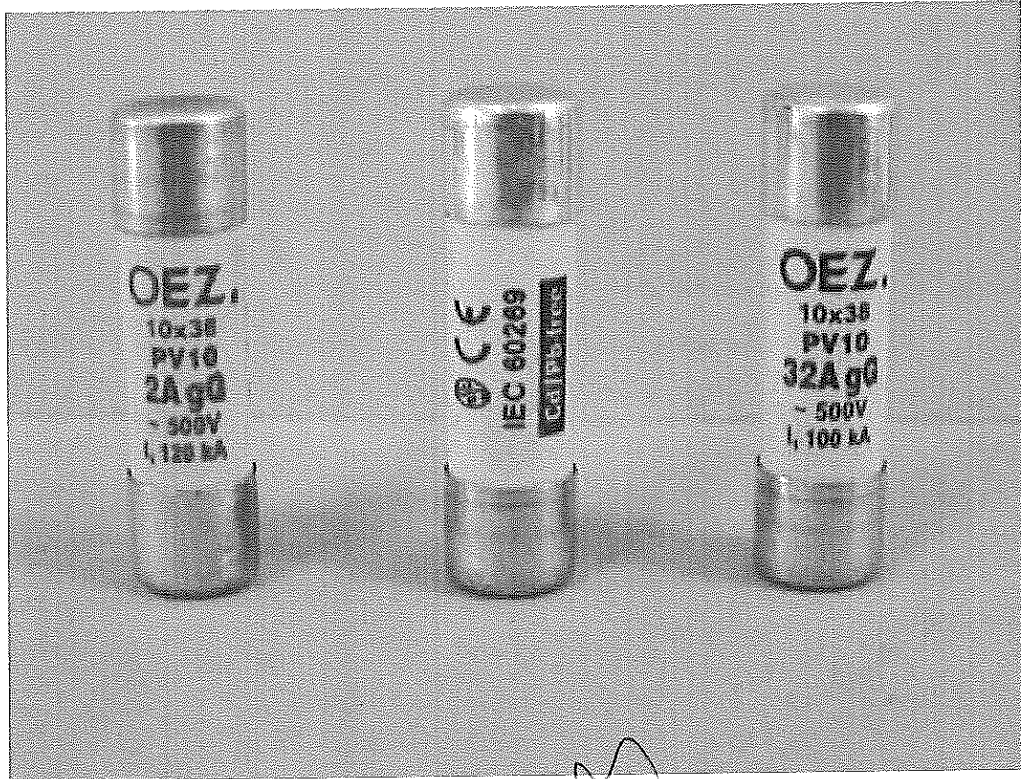

[Handwritten signature]

[Handwritten signature]

БЕЛНО С
ОПРЕДНАНА

ПС
ELECTRIC
BULGARIA

[Handwritten signature]

[Handwritten mark]

TEST REPORT

IEC 60269-1:98 3rd ed.+ Amd1:05; IEC 60269-2: 2nd ed.+ Amd1:95+ Amd2:01; IEC 60269-2-1:04 4th ed.

PV10g6, In = 2 A, dU = 258 mV, č.11

Záznam číslo 27DS044 ze dne 27. 4.2006

Nastavené hodnoty

Ip = 125000 A
 Uef = 550 V
 cosφ = 0.16

Naměřené hodnoty

tt = 0.01 ms
 tc = 0.12 ms
 It = 369 A
 Io = 620 A
 Umax = 640 V
 Uzot = 558 V
 I2tt = 0.68 A2s
 I2tc = 5.22 A2s
 Alfa = 46 st.el.
 Psi = 46 st.el.
 It = 0.00 x Ip
 Ri = 9999.00 MOhm

I1

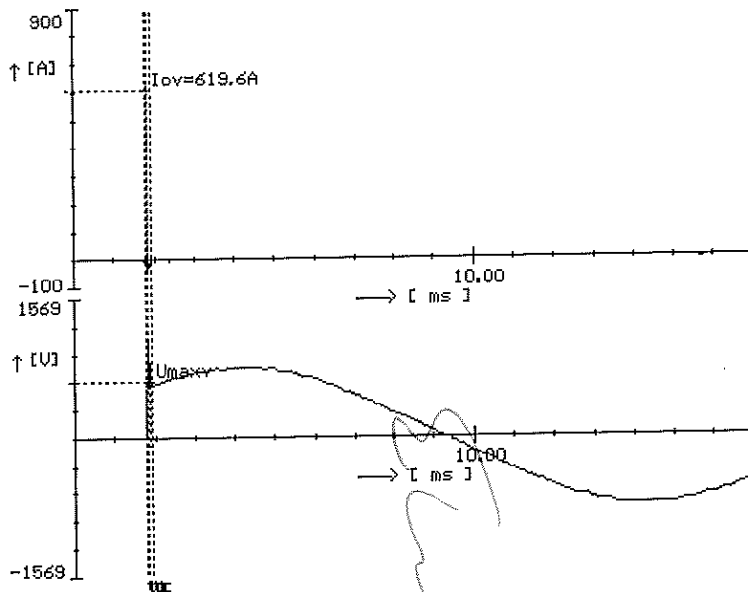

PV10g6, In = 2 A, dU = 260 mV, č.12

Záznam číslo 27DS045 ze dne 27. 4.2006

Nastavené hodnoty

Ip = 125000 A
 Uef = 550 V
 cosφ = 0.16

Naměřené hodnoty

tt = 0.01 ms
 tc = 0.15 ms
 It = 675 A
 Io = 623 A
 Umax = 916 V
 Uzot = 558 V
 I2tt = 0.39 A2s
 I2tc = 4.23 A2s
 Alfa = 86 st.el.
 Psi = 86 st.el.
 It = 0.01 x Ip
 Ri = 9999.00 MOhm

I1

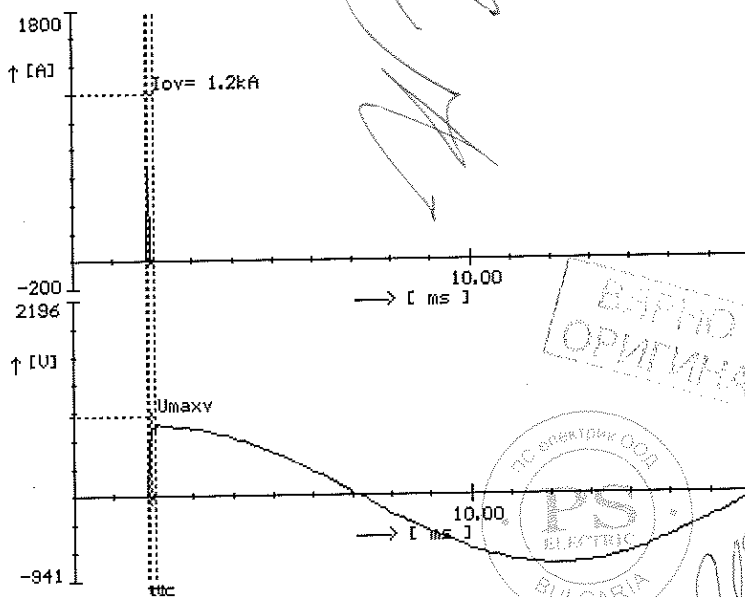

ВЕРНО С
ОРИГИНАЛА

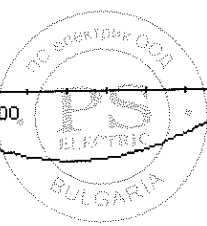

Handwritten signature

Handwritten signature

Handwritten initials 'AS'

TEST REPORT

IEC 60269-1:98 3rd ed.+ Amd1:05; IEC 60269-2: 2nd ed.+ Amd1:95+ Amd2:01; IEC 60269-2-1:04 4th ed.

PU10g6, In = 2 A, dU = 275 mV, č.13

Záznam číslo 27DS046 ze dne 27. 4.2006

Nastavené hodnoty

Ip = 125000 A
 Uef = 550 V
 cosφ = 0.16

Naměřené hodnoty

tt = 0.01 ms
 tc = 0.10 ms
 It = 118 A
 Io = 494 A
 Umax = 803 V
 Uzot = 558 V
 I2tt = 0.07 A2s
 I2tc = 2.66 A2s
 Alfa = 84 st.el.
 Psi = 84 st.el.
 It = 0.00 x Ip
 Ri = 9999.00 MOhm

I1

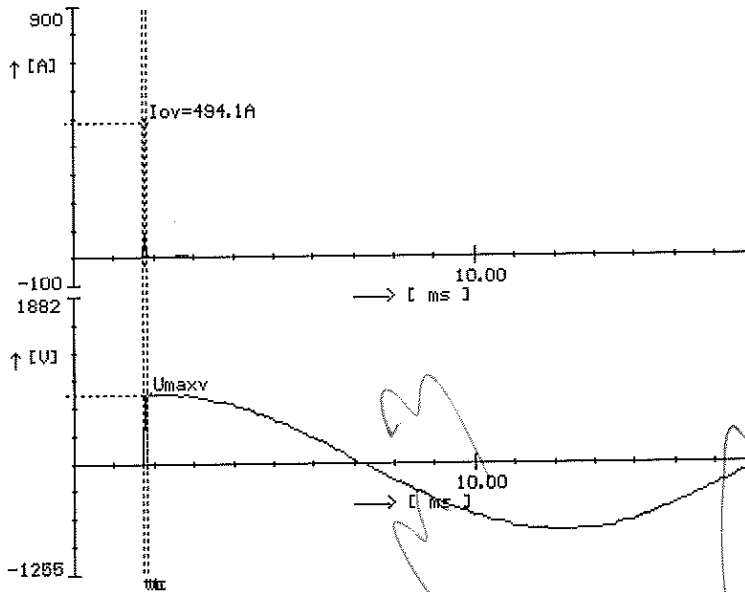

PU10g6, In = 4 A, dU = 220 mV, c. 11

Záznam číslo 27DS041 ze dne 27. 4.2006

Nastavené hodnoty

Ip = 125000 A
 Uef = 550 V
 cosφ = 0.16

Naměřené hodnoty

tt = 0.03 ms
 tc = 0.04 ms
 It = 256 A
 Io = 802 A
 Umax = 1104 V
 Uzot = 558 V
 I2tt = 0.36 A2s
 I2tc = 4.92 A2s
 Alfa = 84 st.el.
 Psi = 85 st.el.
 It = 0.01 x Ip
 Ri = 9999.00 MOhm

I1

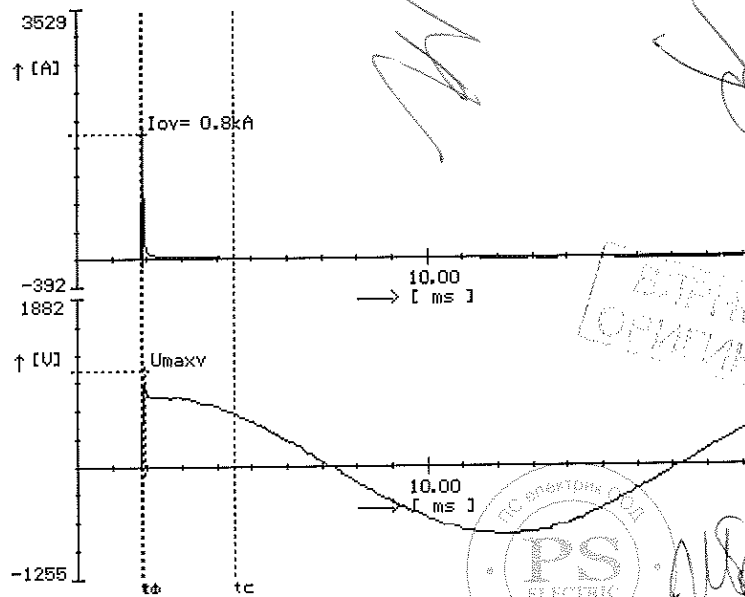

Handwritten mark

49

TEST REPORT

IEC 60269-1:98 3rd ed.+ Amd1:05; IEC 60269-2: 2nd ed.+ Amd1:95+ Amd2:01; IEC 60269-2-1:04 4th ed.

PV10g6, In = 4 A, dU = 218 mV, č.12

Záznam číslo 27DS042 ze dne 27. 4.2006

Nastavené hodnoty

Ip = 125000 A
 Uef = 550 V
 cosφ = 0.16

Naměřené hodnoty

tt = 0.03 ms
 tc = 0.04 ms
 It = 239 A
 Io = 591 A
 Umax = 1104 V
 Uzot = 558 V
 I2tt = 0.24 A2s
 I2tc = 4.39 A2s
 Alfa = 83 st.el.
 Psi = 84 st.el.
 It = 0.01 × Ip
 Ri = 9999.00 MOhm

I1

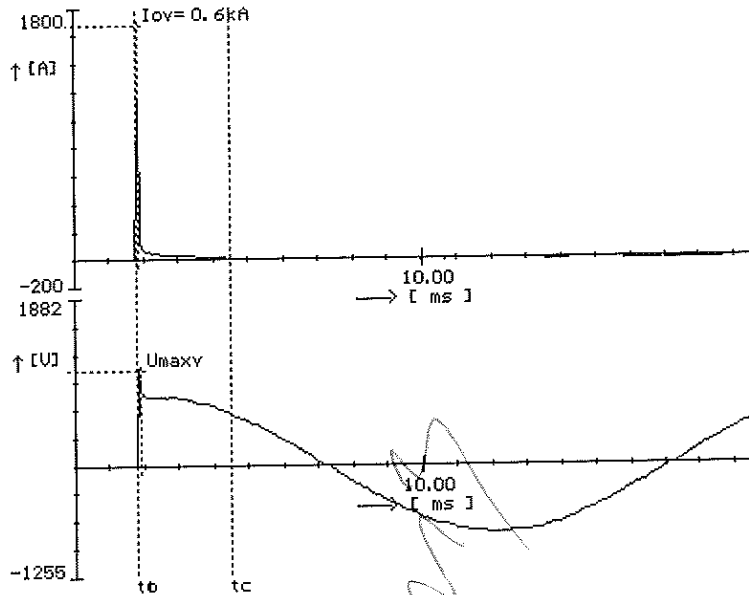

PV10g6, In = 4 A, dU = 216 mV, č.13

Záznam číslo 27DS043 ze dne 27. 4.2006

Nastavené hodnoty

Ip = 125000 A
 Uef = 550 V
 cosφ = 0.16

Naměřené hodnoty

tt = 0.01 ms
 tc = 0.12 ms
 It = 243 A
 Io = 627 A
 Umax = 1100 V
 Uzot = 558 V
 I2tt = 0.30 A2s
 I2tc = 4.59 A2s
 Alfa = 46 st.el.
 Psi = 46 st.el.
 It = 0.01 × Ip
 Ri = 9999.00 MOhm

I1

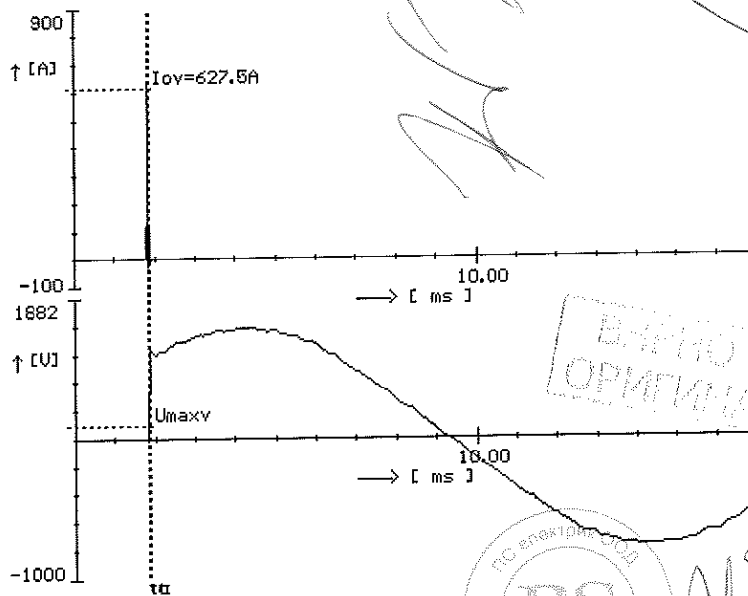

EMPHO C
 OPTIMIZOVANA

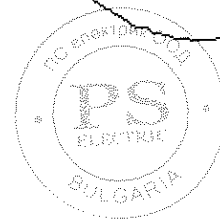

50

[Handwritten signature]

TEST REPORT

IEC 60269-1:98 3rd ed.+ Amd1:05; IEC 60269-2: 2nd ed.+ Amd1:95+ Amd2:01; IEC 60269-2-1:04 4th ed.

PV10gB, In = 6 A, dU = 116 mV, č.11

Záznam číslo 27DS038 ze dne 27. 4.2006

Nastavené hodnoty

Ip = 125000 A
 Uef = 550 V
 cosφ = 0.16

Naměřené hodnoty

tt = 0.01 ms
 tc = 4.60 ms
 It = 1337 A
 Io = 1592 A
 Umax = 803 V
 Uzot = 558 V
 I2tt = 14.57 A2s
 I2tc = 100.23 A2s
 Alfa = 46 st.el.
 Psi = 46 st.el.
 It = 0.01 x Ip
 Ri = 9999.00 MOhm

I1

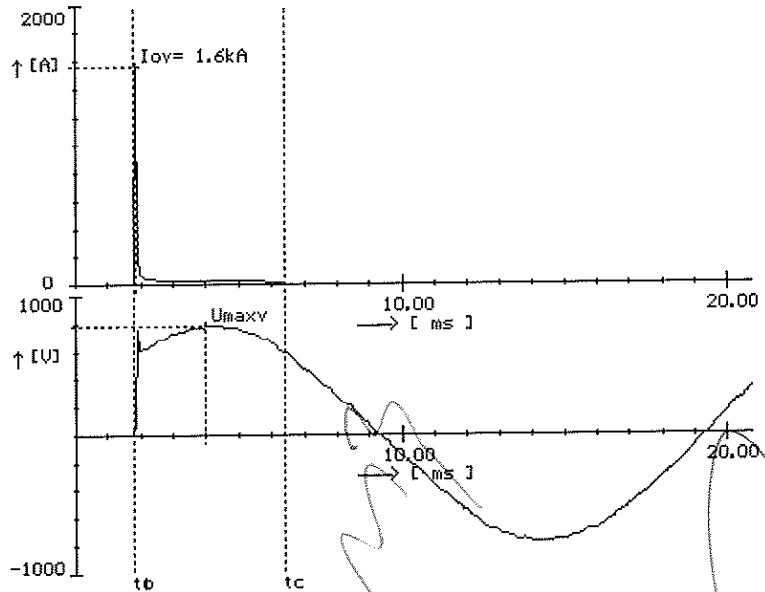

PV10gB, In = 6 A, dU = 116 mV, č.12

Záznam číslo 27DS039 ze dne 27. 4.2006

Nastavené hodnoty

Ip = 125000 A
 Uef = 550 V
 cosφ = 0.16

Naměřené hodnoty

tt = 0.03 ms
 tc = 2.74 ms
 It = 1420 A
 Io = 1859 A
 Umax = 1167 V
 Uzot = 558 V
 I2tt = 15.75 A2s
 I2tc = 152.49 A2s
 Alfa = 84 st.el.
 Psi = 85 st.el.
 It = 0.01 x Ip
 Ri = 9999.00 MOhm

I1

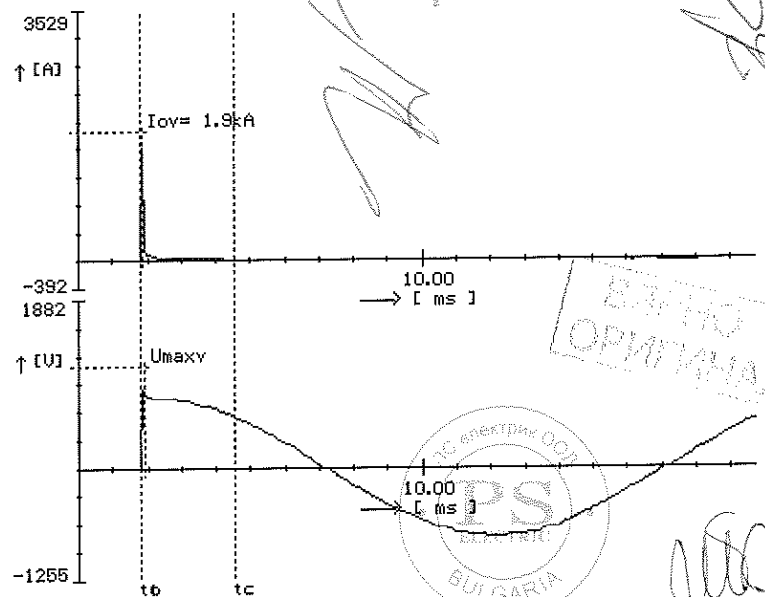

51

TEST REPORT

IEC 60269-1:98 3rd ed.+ Amd1:05; IEC 60269-2: 2nd ed.+ Amd1:95+ Amd2:01; IEC 60269-2-1:04 4th ed.

PV10g9, I_n = 6 A, dU = 117 mV, č.13

Záznam číslo 27DS040 ze dne 27. 4.2006

Nastavené hodnoty

I_p = 125000 A
 U_{ef} = 550 V
 cosφ = 0.16

Naměřené hodnoty

t_t = 0.02 ms
 t_c = 2.42 ms
 I_t = 1349 A
 I_o = 1788 A
 U_{max} = 929 V
 U_{zot} = 558 V
 I_{2tt} = 13.57 A²s
 I_{2tc} = 129.53 A²s
 Alfa = 84 st.el.
 Psi = 84 st.el.
 I_t = 0.01 × I_p
 R_i = 9999.00 MOhm

I1

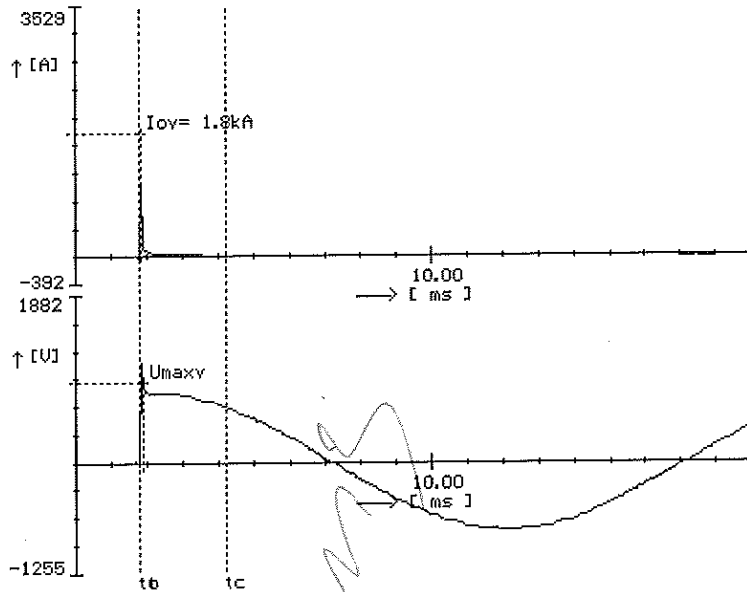

PV10g6, I_n = 8 A, dU = 106 mV, č.11

Záznam číslo 27DS035 ze dne 27. 4.2006

Nastavené hodnoty

I_p = 125000 A
 U_{ef} = 550 V
 cosφ = 0.16

Naměřené hodnoty

t_t = 0.04 ms
 t_c = 2.77 ms
 I_t = 1902 A
 I_o = 2059 A
 U_{max} = 1217 V
 U_{zot} = 562 V
 I_{2tt} = 46.28 A²s
 I_{2tc} = 220.47 A²s
 Alfa = 84 st.el.
 Psi = 85 st.el.
 I_t = 0.02 × I_p
 R_i = 9999.00 MOhm

I1

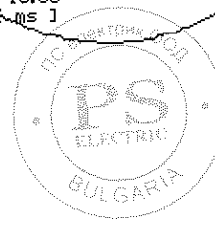
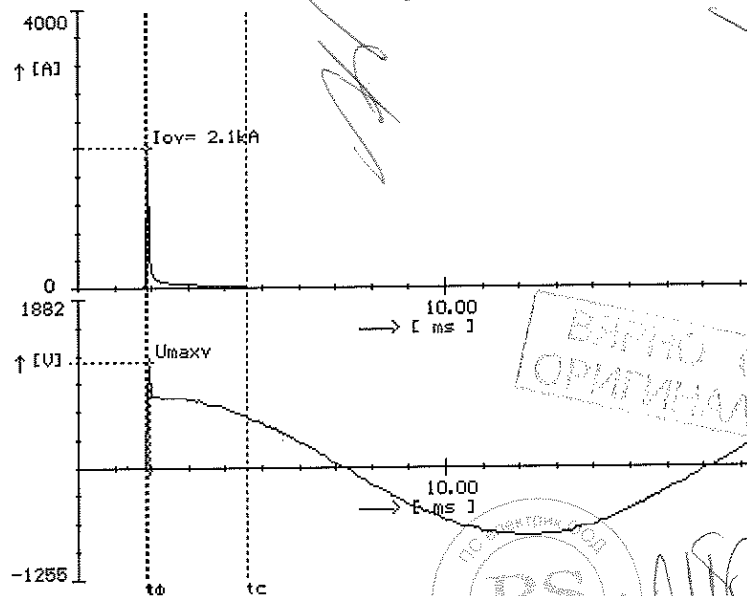

ВЕРНО С
 ОПИТНАМА

52

[Handwritten mark]

TEST REPORT

IEC 60269-1:98 3rd ed.+ Amd1:05; IEC 60269-2: 2nd ed.+ Amd1:95+ Amd2:01; IEC 60269-2-1:04 4th ed.

PV10g6, In = 8 A, dU = 106 mV, č.12

Záznam číslo 27D8036 ze dne 27. 4.2006

Nastavené hodnoty

Ip = 125000 A
 Uef = 550 V
 cosφ = 0.16

Naměřené hodnoty

tt = 0.04 ms
 tc = 2.11 ms
 It = 1863 A
 Io = 2059 A
 Umax = 1217 V
 Uzot = 558 V
 I2tt = 39.05 A2s
 I2tc = 217.23 A2s
 Alfa = 83 st.el.
 Psi = 84 st.el.
 It = 0.01 × Ip
 Ri = 9999.00 MOhm

I1

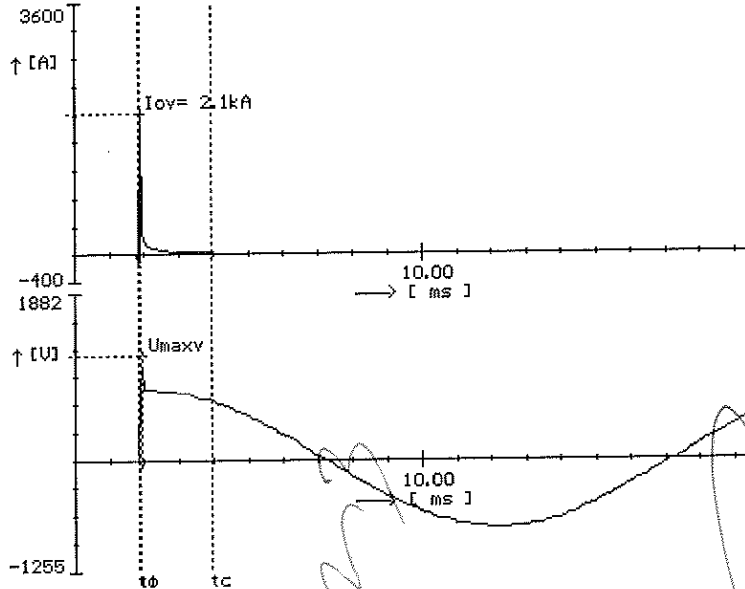

PV10g6, In = 8 A, dU = 107 mV, č.13

Záznam číslo 27D8037 ze dne 27. 4.2006

Nastavené hodnoty

Ip = 125000 A
 Uef = 550 V
 cosφ = 0.16

Naměřené hodnoty

tt = 0.01 ms
 tc = 3.89 ms
 It = 1839 A
 Io = 1392 A
 Umax = 1029 V
 Uzot = 558 V
 I2tt = 38.01 A2s
 I2tc = 148.12 A2s
 Alfa = 46 st.el.
 Psi = 46 st.el.
 It = 0.01 × Ip
 Ri = 9999.00 MOhm

I1

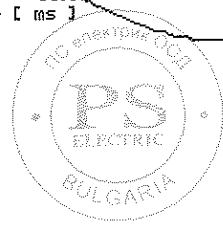
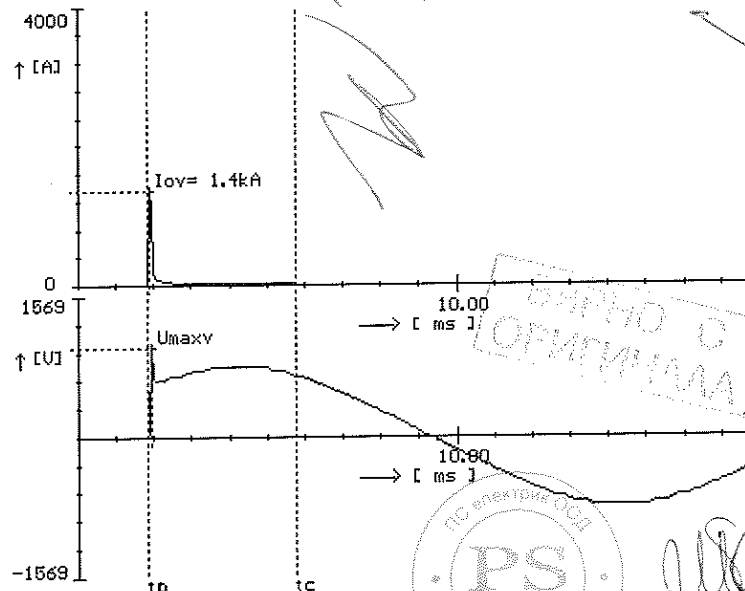

Handwritten signature

53

Handwritten signature

TEST REPORT

IEC 60269-1:98 3rd ed.+ Amd1:05; IEC 60269-2: 2nd ed.+ Amd1:95+ Amd2:01; IEC 60269-2-1:04 4th ed.

PV10gG, In = 12 A, dU = 88 mV, č.11

Záznam číslo 27D8031 ze dne 27. 4.2006

Nastavené hodnoty

Ip = 125000 A
 Uef = 550 V
 cosφ = 0.16

Naměřené hodnoty

tt = 0.06 ms
 tc = 4.94 ms
 It = 2647 A
 Io = 2647 A
 Umax = 1067 V
 Uzot = 558 V
 I2tt = 146.38 A2s
 I2tc = 479.85 A2s
 Alfa = 48 st.el.
 Psi = 49 st.el.
 It = 0.02 x Ip
 Ri = 9999.00 MOhm

I1

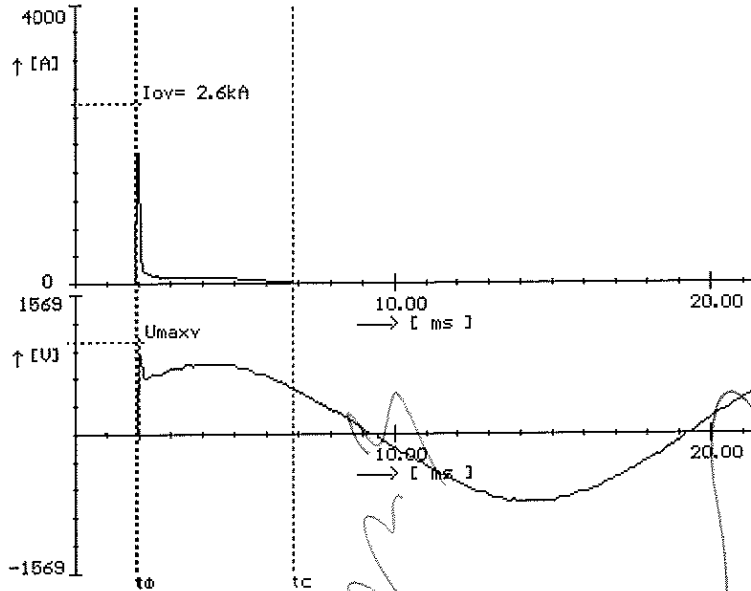

PV10gG, In = 12 A, dU = 88 mV, č.12

Záznam číslo 27D8032 ze dne 27. 4.2006

Nastavené hodnoty

Ip = 125000 A
 Uef = 550 V
 cosφ = 0.16

Naměřené hodnoty

tt = 0.04 ms
 tc = 3.06 ms
 It = 2216 A
 Io = 3039 A
 Umax = 1405 V
 Uzot = 558 V
 I2tt = 67.44 A2s
 I2tc = 588.86 A2s
 Alfa = 86 st.el.
 Psi = 87 st.el.
 It = 0.02 x Ip
 Ri = 9999.00 MOhm

I1

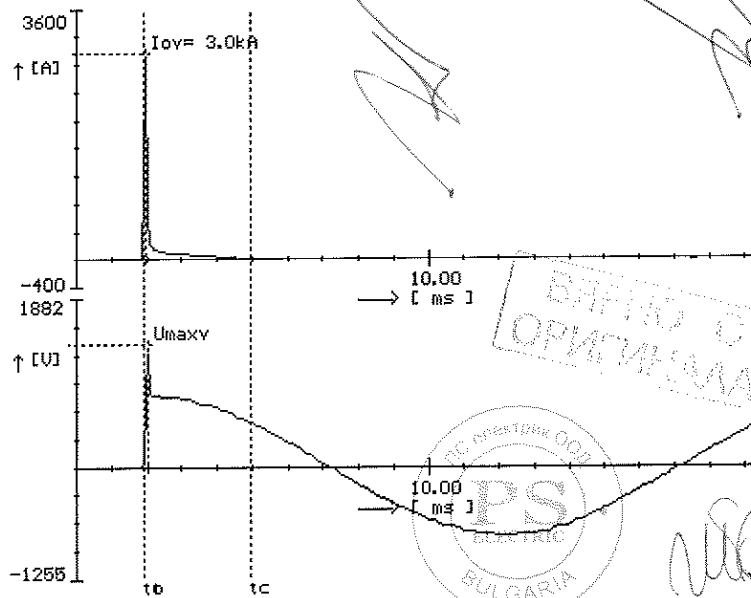

54

TEST REPORT

IEC 60269-1:98 3rd ed.+ Amd1:05; IEC 60269-2: 2nd ed.+ Amd1:95+ Amd2:01; IEC 60269-2-1:04 4th ed.

PV10g6, In = 12 A, dU = 88 mV, č.13

Záznam číslo 27DS033 ze dne 27. 4.2006

Nastavené hodnoty

Ip = 125000 A
 Uef = 550 V
 cosφ = 0.16

Naměřené hodnoty

tt = 0.04 ms
 tc = 3.18 ms
 It = 2588 A
 Io = 3000 A
 Umax = 1343 V
 Uzot = 558 V
 I2tt = 94.00 A2s
 I2tc = 602.28 A2s
 Alfa = 85 st.el.
 Psi = 86 st.el.
 It = 0.02 × Ip
 Ri = 9999.00 MOhm

I1

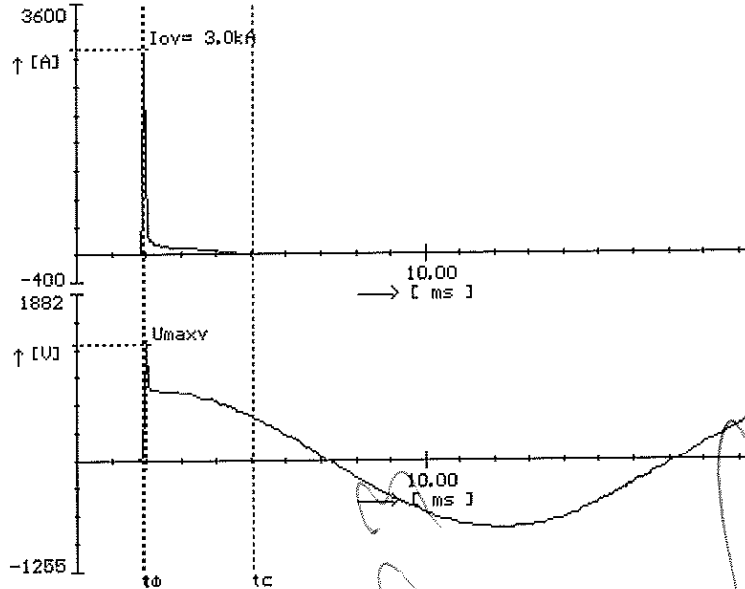

PV10g6, In = 16 A, dU = 90,5 mV, č.11

Záznam číslo 27DS028 ze dne 27. 4.2006

Nastavené hodnoty

Ip = 125000 A
 Uef = 550 V
 cosφ = 0.16

Naměřené hodnoty

tt = 0.06 ms
 tc = 3.51 ms
 It = 2706 A
 Io = 3490 A
 Umax = 1368 V
 Uzot = 558 V
 I2tt = 115.26 A2s
 I2tc = 1102.25 A2s
 Alfa = 85 st.el.
 Psi = 86 st.el.
 It = 0.02 × Ip
 Ri = 9999.00 MOhm

I1

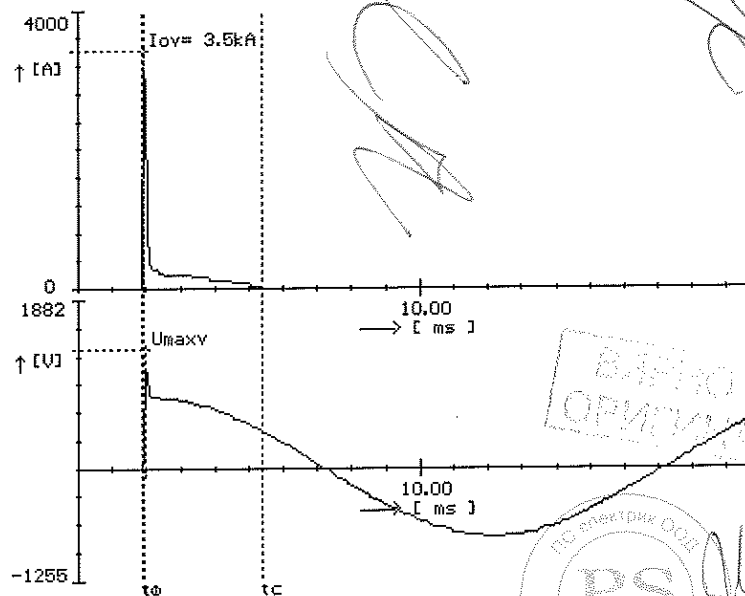

БАНКО С
 ОПИЧКА



55

TEST REPORT

IEC 60269-1:98 3rd ed.+ Amd1:05; IEC 60269-2: 2nd ed.+ Amd1:95+ Amd2:01; IEC 60269-2-1:04 4th ed.

PV10gG, In = 16 A, dU = 90,5 mV, č.12

Záznam číslo 27DS029 ze dne 27. 4.2006

Nastavené hodnoty

Ip = 125000 A
 Uef = 550 V
 cosφ = 0.16

Naměřené hodnoty

tt = 0.06 ms
 tc = 3.39 ms
 It = 3137 A
 Io = 3608 A
 Umax = 1368 V
 Uzot = 558 V
 I2tt = 183.90 A2s
 I2tc = 1091.61 A2s
 Alfa = 86 st.el.
 Psi = 87 st.el.
 It = 0.03 x Ip
 Ri = 9999.00 MOhm

II

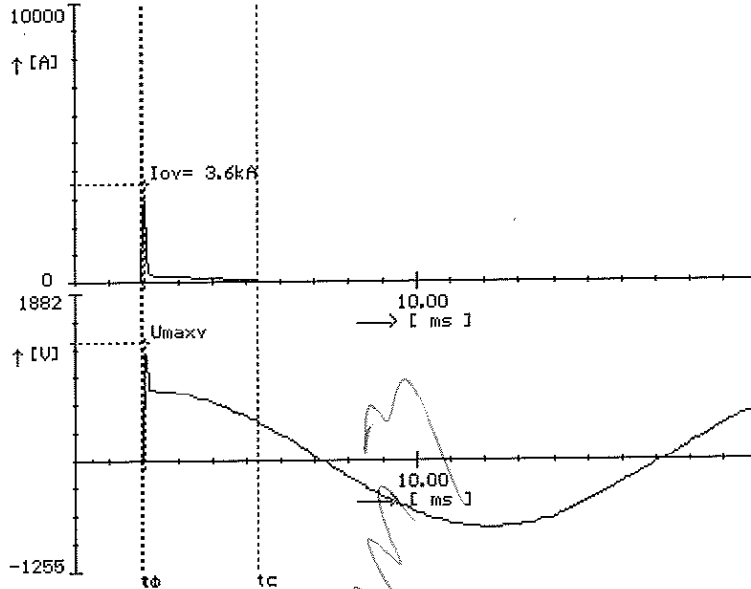

PV10gG, In = 16 A, dU = 92 mV, č.13

Záznam číslo 27DS030 ze dne 27. 4.2006

Nastavené hodnoty

Ip = 125000 A
 Uef = 550 V
 cosφ = 0.16

Naměřené hodnoty

tt = 0.08 ms
 tc = 5.19 ms
 It = 3216 A
 Io = 3294 A
 Umax = 1104 V
 Uzot = 558 V
 I2tt = 253.67 A2s
 I2tc = 866.96 A2s
 Alfa = 48 st.el.
 Psi = 49 st.el.
 It = 0.03 x Ip
 Ri = 9999.00 MOhm

II

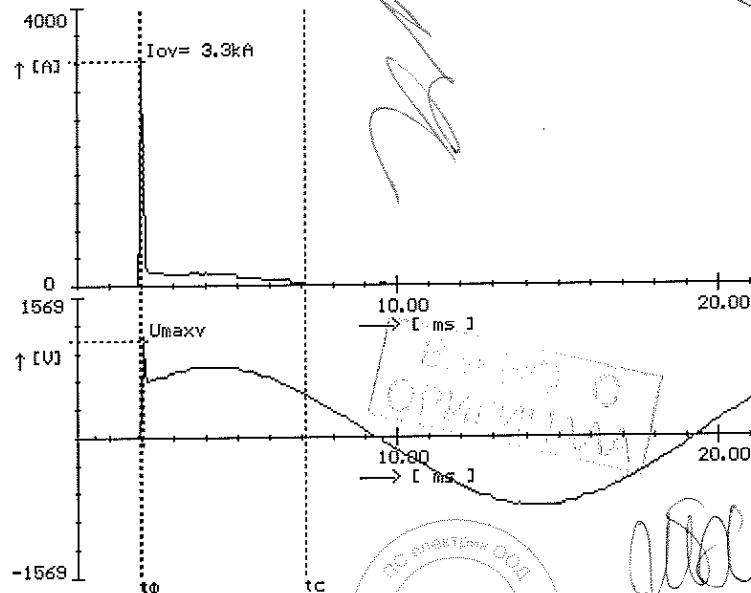

56

TEST REPORT

IEC 60269-1:98 3rd ed.+ Amd1:05; IEC 60269-2: 2nd ed.+ Amd1:95+ Amd2:01; IEC 60269-2-1:04 4th ed.

PV10g6, In = 20 A, dU = 78 mV, ž.11

Záznam číslo 27DS025 ze dne 27. 4.2006

Nastavené hodnoty

Ip = 125000 A
 Uef = 550 V
 cosφ = 0.16

Naměřené hodnoty

tt = 0.09 ms
 tc = 4.68 ms
 It = 3608 A
 Io = 4157 A
 Umax = 1155 V
 Uzot = 558 V
 I2tt = 352.46 A2s
 I2tc = 1685.44 A2s
 Alfa = 48 st.el.
 Psi = 50 st.el.
 It = 0.03 × Ip
 Ri = 9999.00 MOhm

I1

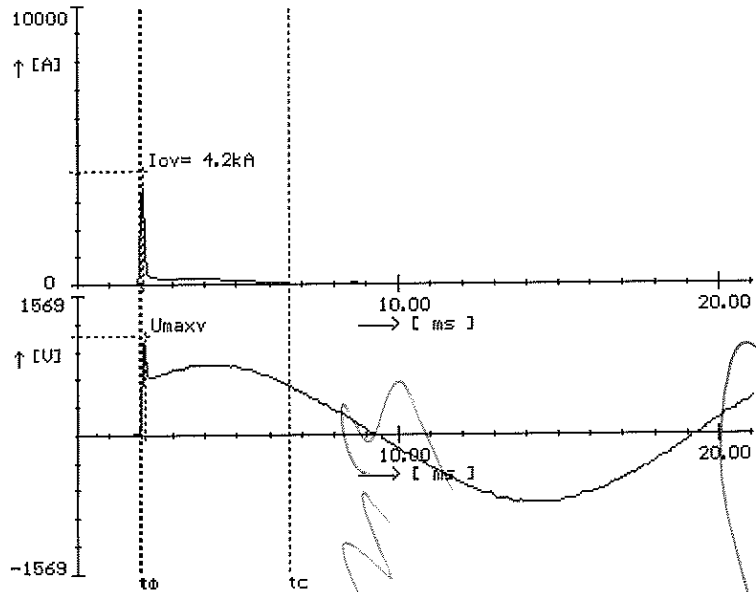

PV10g6, In = 20 A, dU = 78,5 mV, ž.12

Záznam číslo 27DS026 ze dne 27. 4.2006

Nastavené hodnoty

Ip = 125000 A
 Uef = 550 V
 cosφ = 0.16

Naměřené hodnoty

tt = 0.08 ms
 tc = 2.19 ms
 It = 4039 A
 Io = 4627 A
 Umax = 1443 V
 Uzot = 558 V
 I2tt = 368.67 A2s
 I2tc = 1897.79 A2s
 Alfa = 87 st.el.
 Psi = 88 st.el.
 It = 0.03 × Ip
 Ri = 9999.00 MOhm

I1

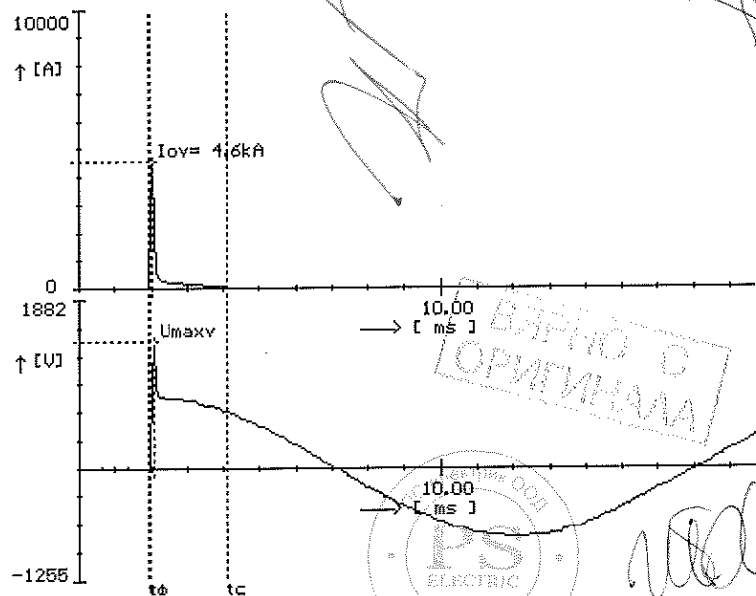

57

TEST REPORT

IEC 60269-1:98 3rd ed.+ Amd1:05; IEC 60269-2: 2nd ed.+ Amd1:95+ Amd2:01; IEC 60269-2-1:04 4th ed.

PV10gG, In = 20 A, dU = 79 mV, č.13

Záznam číslo 27DS027 ze dne 27. 4.2006

Nastavené hodnoty

Ip = 125000 A
 Uef = 550 V
 cosφ = 0.16

Naměřené hodnoty

tt = 0.07 ms
 tc = 2.58 ms
 It = 3882 A
 Io = 4588 A
 Umax = 1418 V
 Uzot = 589 V
 I2tt = 330.33 A2s
 I2tc = 1974.36 A2s
 Alfa = 85 st.el.
 Psi = 86 st.el.
 It = 0.03 × Ip
 Ri = 9999.00 MOhm

I1

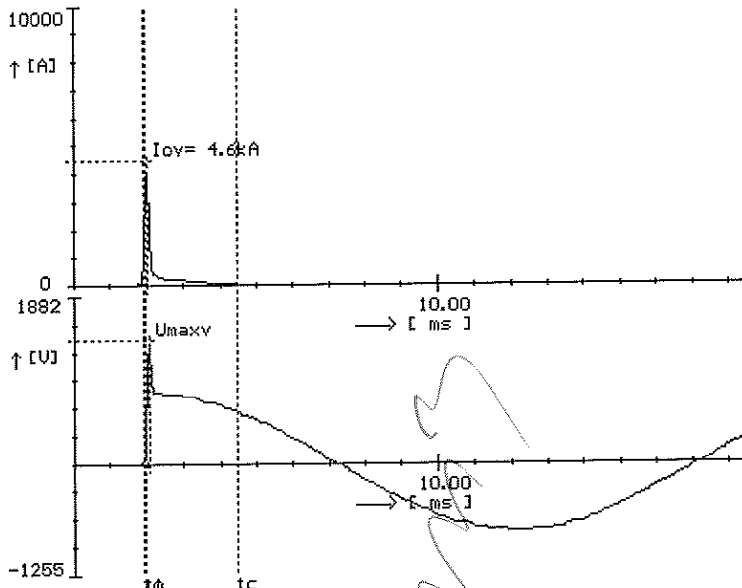

PV10gG, In = 25 A, dU = 77,5 mV, č.14

Záznam číslo 27DS022 ze dne 27. 4.2006

Nastavené hodnoty

Ip = 125000 A
 Uef = 550 V
 cosφ = 0.16

Naměřené hodnoty

tt = 0.08 ms
 tc = 2.71 ms
 It = 4667 A
 Io = 5333 A
 Umax = 1368 V
 Uzot = 589 V
 I2tt = 595.36 A2s
 I2tc = 3121.41 A2s
 Alfa = 76 st.el.
 Psi = 77 st.el.
 It = 0.04 × Ip
 Ri = 9999.00 MOhm

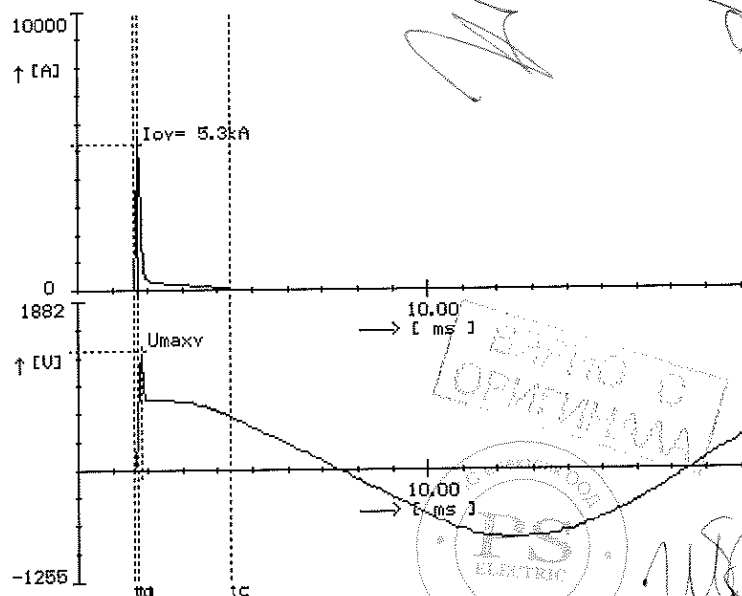

[Handwritten signature]

58

TEST REPORT

IEC 60269-1:98 3rd ed.+ Amd1:05; IEC 60269-2: 2nd ed.+ Amd1:95+ Amd2:01; IEC 60269-2-1:04 4th ed.

PU10g0, I_n = 25 A, dU = 77,5 mV, č.15

Záznam číslo 27D6023 ze dne 27. 4.2006

Nastavené hodnoty

I_p = 125000 A
 U_{ef} = 550 V
 cosφ = 0.16

Naměřené hodnoty

t_t = 0.09 ms
 t_c = 2.23 ms
 I_t = 4824 A
 I_o = 5490 A
 U_{max} = 1418 V
 U_{zot} = 558 V
 I_{2tt} = 642.75 A²s
 I_{2tc} = 3304.46 A²s
 Alfa = 90 st.el.
 Psi = 92 st.el.
 I_t = 0.04 × I_p
 R_i = 9998.00 MOhm

I1

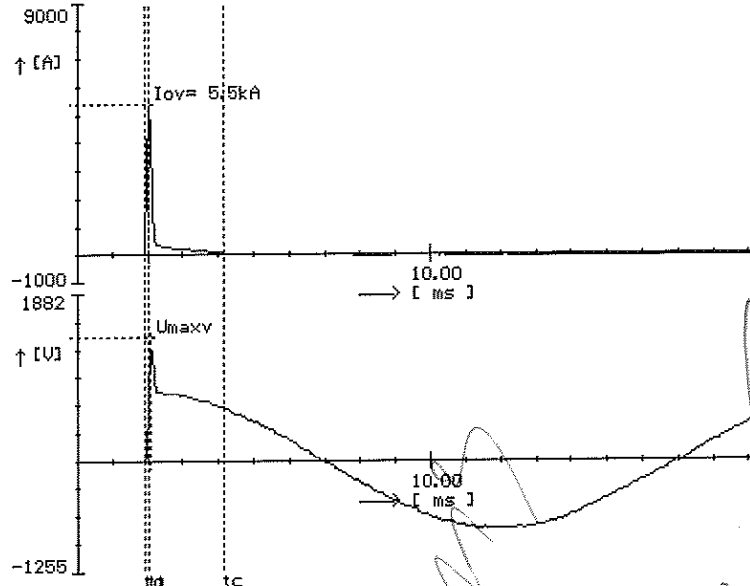

PU10g0, I_n = 25 A, dU = 77,5 mV, č.16

Záznam číslo 27D6024 ze dne 27. 4.2006

Nastavené hodnoty

I_p = 125000 A
 U_{ef} = 550 V
 cosφ = 0.16

Naměřené hodnoty

t_t = 0.12 ms
 t_c = 4.27 ms
 I_t = 4157 A
 I_o = 4902 A
 U_{max} = 1117 V
 U_{zot} = 558 V
 I_{2tt} = 523.02 A²s
 I_{2tc} = 3082.31 A²s
 Alfa = 50 st.el.
 Psi = 52 st.el.
 I_t = 0.03 × I_p
 R_i = 9998.00 MOhm

I1

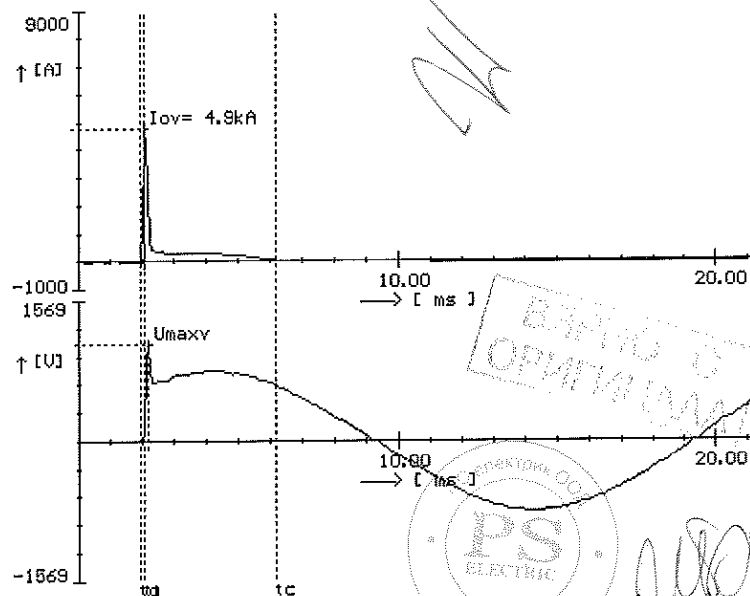

TEST REPORT

IEC 60269-1:98 3rd ed.+ Amd1:05; IEC 60269-2: 2nd ed.+ Amd1:95+ Amd2:01; IEC 60269-2-1:04 4th ed.

PU10g6, In = 32 A, dU = 59,5 mV, č.14

Záznam číslo 22ES048 ze dne 22. 5.2006

Nastavené hodnoty

Ip = 103000 A
 Uef = 550 V
 cosfi = 0.17

Naměřené hodnoty

tt = 0.18 ms
 tc = 3.73 ms
 It = 6235 A
 Io = 6549 A
 Umax = 1355 V
 Uzot = 552 V
 I2tt = 2309.44 A2s
 I2tc = 6160.38 A2s
 Alfa = 47 st.el.
 Psi = 50 st.el.
 It = 0.06 × Ip
 Ri = 9999.00 MOhm

I1

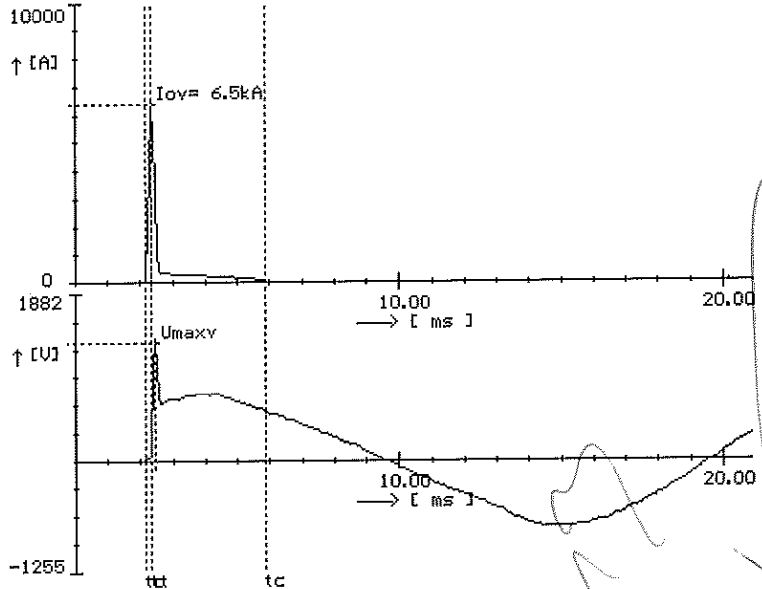

PU10g6, In = 32 A, dU = 60 mV, č.15

Záznam číslo 22ES049 ze dne 22. 5.2006

Nastavené hodnoty

Ip = 103000 A
 Uef = 550 V
 cosfi = 0.17

Naměřené hodnoty

tt = 0.14 ms
 tc = 2.28 ms
 It = 6941 A
 Io = 7137 A
 Umax = 1531 V
 Uzot = 549 V
 I2tt = 2434.06 A2s
 I2tc = 7303.22 A2s
 Alfa = 84 st.el.
 Psi = 86 st.el.
 It = 0.07 × Ip
 Ri = 9999.00 MOhm

I1

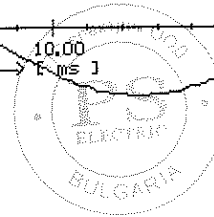
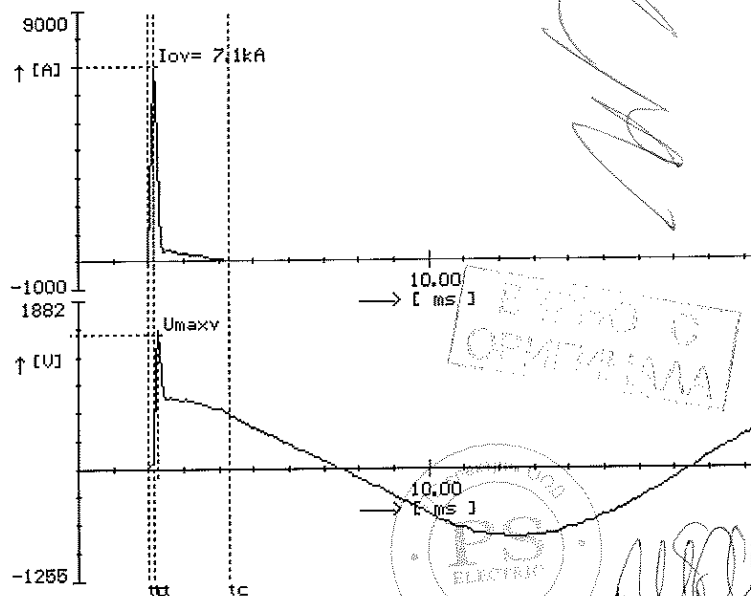

60

TEST REPORT

IEC 60269-1:98 3rd ed.+ Amd1:05; IEC 60269-2: 2nd ed.+ Amd1:95+ Amd2:01; IEC 60269-2-1:04 4th ed.

PV10g6, In = 32 A, dU = 60,5 mV, č.16.2

Záznam číslo 22ES051 ze dne 22. 5.2006

Nastavené hodnoty

Ip = 103000 A
 Uef = 550 V
 cosφi = 0.17

Naměřené hodnoty

tt = 0.15 ms
 tc = 2.60 ms
 It = 6980 A
 Io = 7216 A
 Umax = 1544 V
 Uzot = 555 V
 I2tt = 2487.93 A2s
 I2tc = 7564.54 A2s
 Alfa = 83 st.el.
 Psi = 86 st.el.
 It = 0.07 x Ip
 Ri = 9999.00 MOhm

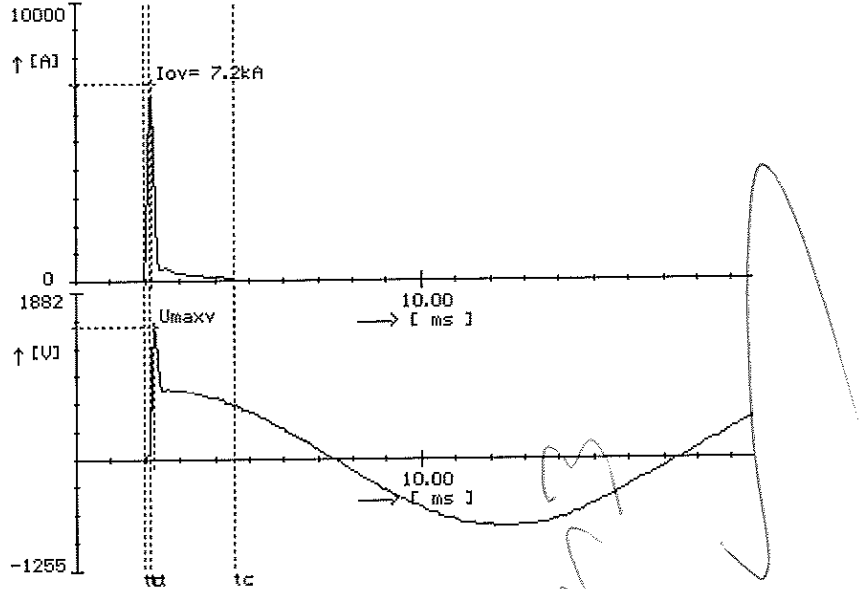

PV10g6, In = 32 A, dU = 61 mV, č.17.2

Záznam číslo 99997 ze dne 9. 6.2006

Nastavené hodnoty

Ip = 1722 A
 Uef = 552 V
 cosφi = 0.29

Naměřené hodnoty

tt = 4.00 ms
 tc = 6.70 ms
 It = 1808 A
 Io = 1808 A
 Umax = 1584 V
 Uzot = 552 V
 I2tt = 3462.27 A2s
 I2tc = 5787.80 A2s
 Alfa = 5 st.el.
 Psi = 76 st.el.
 It = 1.05 x Ip
 Ri = 9999.00 MOhm

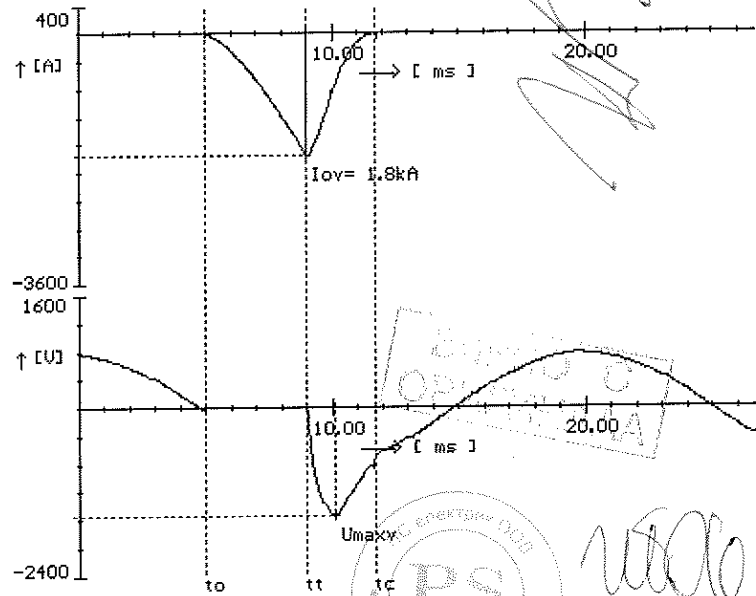

I2105

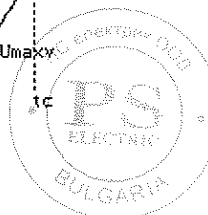

61

TEST REPORT

IEC 60269-1:98 3rd ed.+ Amd1:05; IEC 60269-2: 2nd ed.+ Amd1:95+ Amd2:01; IEC 60269-2-1:04 4th ed.

PV10g9, In = 32 A, dU = 61 mV, č.18

Záznam číslo 99988 ze dne 9. 6.2006

Nastavené hodnoty

Ip = 1722 A
 Uef = 552 V
 cosff = 0.29

Naměřené hodnoty

tt = 4.10 ms
 tc = 6.80 ms
 It = 1792 A
 Io = 1792 A
 Umax = 1488 V
 Uzot = 552 V
 I2tt = 3382.42 A2s
 I2tc = 5653.58 A2s
 Alfa = 0 st.el.
 Psi = 73 st.el.
 It = 1.04 x Ip
 Ri = 9999.00 MOhm

I2104

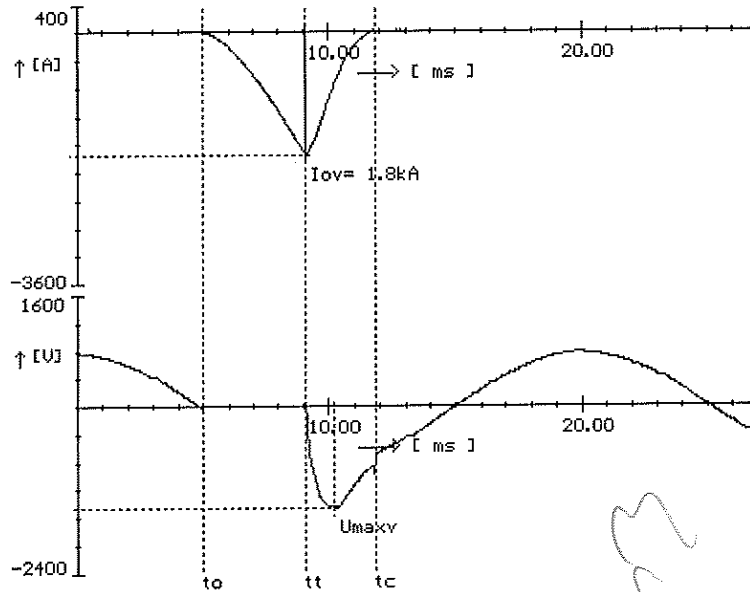

PV10g6, In = 32 A, dU = 61 mV, č.19

Záznam číslo 99999 ze dne 9. 6.2006

Nastavené hodnoty

Ip = 1722 A
 Uef = 552 V
 cosff = 0.29

Naměřené hodnoty

tt = 3.87 ms
 tc = 7.17 ms
 It = 1728 A
 Io = 1760 A
 Umax = 1376 V
 Uzot = 552 V
 I2tt = 3043.11 A2s
 I2tc = 6232.34 A2s
 Alfa = 5 st.el.
 Psi = 74 st.el.
 It = 1.00 x Ip
 Ri = 9999.00 MOhm

I2100

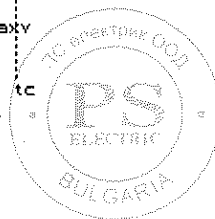
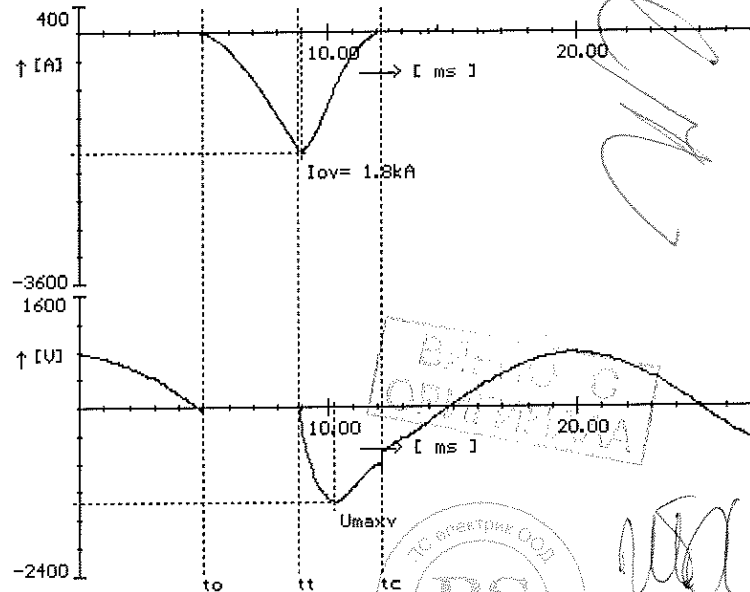

[Handwritten signature]

[Handwritten signature]

TEST REPORT

IEC 60269-1:98 3rd ed.+ Amd1:05; IEC 60269-2: 2nd ed.+ Amd1:95+ Amd2:01; IEC 60269-2-1:04 4th ed.

PV10g6, In = 25 A, dU = 73 mV, č.17

Záznam číslo 1604 ze dne 23. 2.2007

Nastavené hodnoty

Ip = 1260 A
 Uef = 552 V
 cosφ = 0.27

Naměřené hodnoty

tt = 3.73 ms
 tc = 7.27 ms
 It = 1216 A
 Io = 1216 A
 Umax = 1376 V
 Uzot = 552 V
 I2tt = 1431.07 A2s
 I2tc = 2574.38 A2s
 Alfa = 5 st.el.
 Psi = 72 st.el.
 It = 0.97 × Ip
 Ri = 9999.00 MOhm

I2097

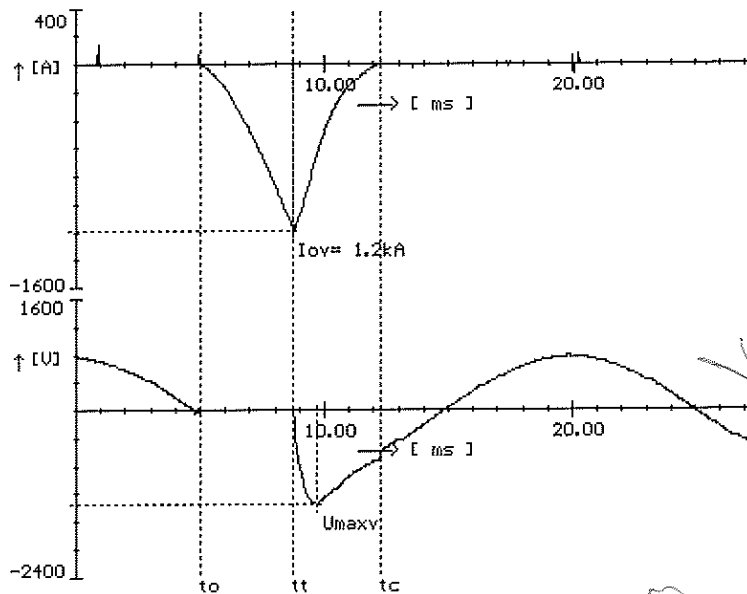

PV10g6, In = 25 A, dU = 73 mV, č.18

Záznam číslo 1605 ze dne 23. 2.2007

Nastavené hodnoty

Ip = 1260 A
 Uef = 552 V
 cosφ = 0.27

Naměřené hodnoty

tt = 3.73 ms
 tc = 7.43 ms
 It = 1184 A
 Io = 1208 A
 Umax = 1400 V
 Uzot = 552 V
 I2tt = 1324.70 A2s
 I2tc = 2449.59 A2s
 Alfa = 3 st.el.
 Psi = 70 st.el.
 It = 0.94 × Ip
 Ri = 9999.00 MOhm

I2094

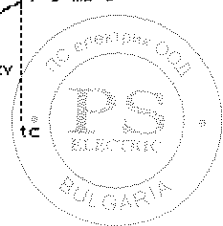
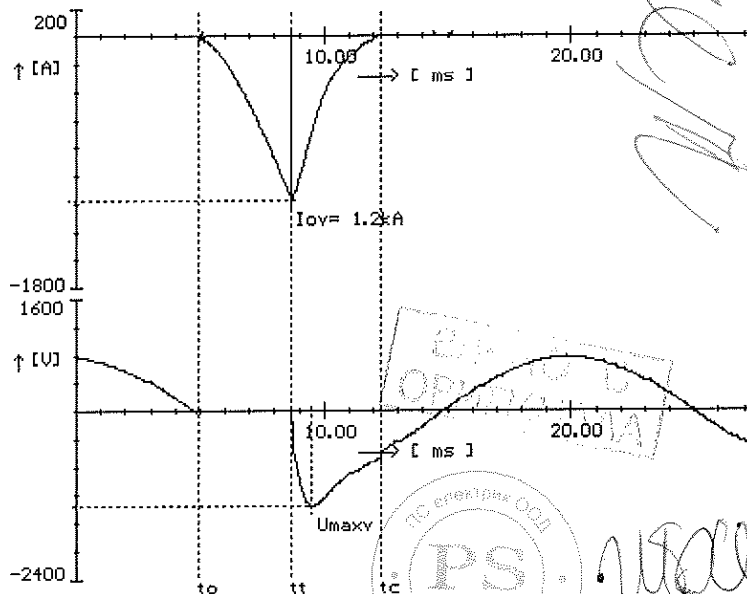

Handwritten signature

63

TEST REPORT

IEC 60269-1:98 3rd ed.+ Amd1:05; IEC 60269-2: 2nd ed.+ Amd1:95+ Amd2:01; IEC 60269-2-1:04 4th ed.

PV10g6, In = 25 A, dU = 74,5 mV, č.19

Záznam číslo 1606 ze dne 23. 2.2007

Nastavené hodnoty

Ip = 1260 A
 Uef = 552 V
 cosφ = 0.27

Naměřené hodnoty

tt = 3.67 ms
 tc = 7.17 ms
 It = 1200 A
 Io = 1216 A
 Umax = 1368 V
 Uzot = 552 V
 I2tt = 1369.32 A2s
 I2tc = 2543.83 A2s
 Alfa = 3 st.el.
 Psi = 68 st.el.
 It = 0.95 × Ip
 Ri = 9999.00 MOhm

I2095

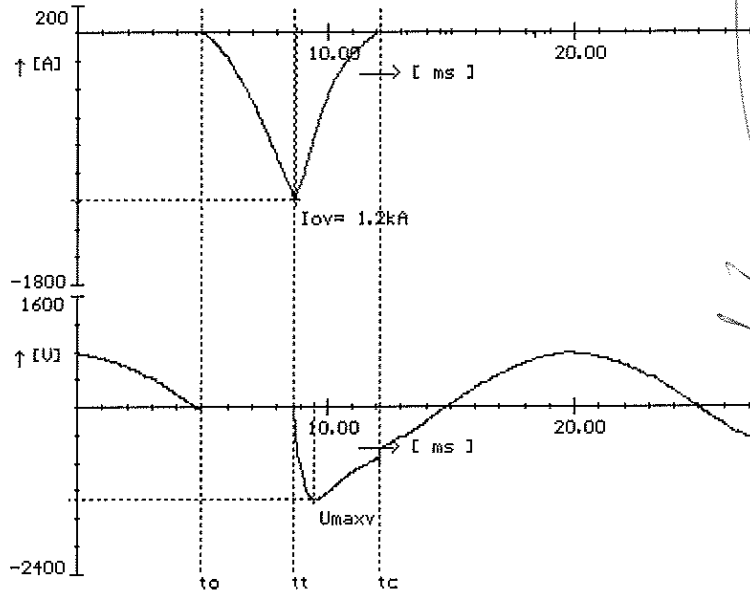

PV10g6, In = 20 A, dU = 79,5 mV, č.14

Záznam číslo 99989 ze dne 9. 6.2006

Nastavené hodnoty

Ip = 892.78 A
 Uef = 556 V
 cosφ = 0.24

Naměřené hodnoty

tt = 3.80 ms
 tc = 7.70 ms
 It = 908.00 A
 Io = 928.00 A
 Umax = 1384 V
 Uzot = 560 V
 I2tt = 765.65 A2s
 I2tc = 1670.82 A2s
 Alfa = 0 st.el.
 Psi = 68 st.el.
 It = 0.91 × Ip
 Ri = 9999.00 MOhm

I2091

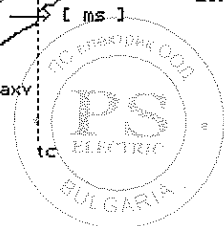
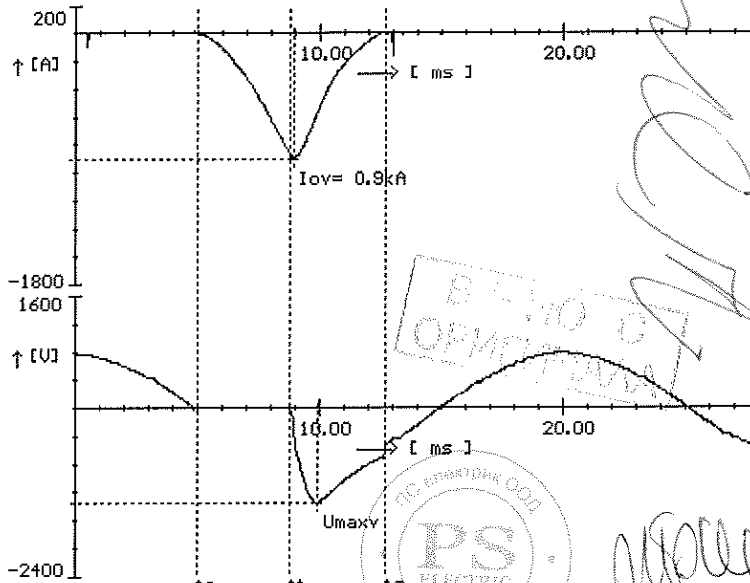

[Handwritten signature]

[Handwritten signature]
 04

TEST REPORT

IEC 60269-1:98 3rd ed.+ Amd1:05; IEC 60269-2: 2nd ed.+ Amd1:95+ Amd2:01; IEC 60269-2-1:04 4th ed.

PV10g6, In = 20 A, dU = 79.5 mV, č.15

Záznam číslo 99990 ze dne 9. 6.2006

Nastavené hodnoty

Ip = 992.78 A
 Uef = 556 V
 cosφ = 0.24

Naměřené hodnoty

tt = 3.63 ms
 tc = 7.37 ms
 It = 896.00 A
 Io = 912.00 A
 Umax = 1328 V
 Uzot = 560 V
 I2tt = 736.08 A2s
 I2tc = 1577.71 A2s
 Alfa = 3 st.el.
 Psi = 68 st.el.
 It = 0.90 × Ip
 Ri = 9999.00 MOhm

I2090

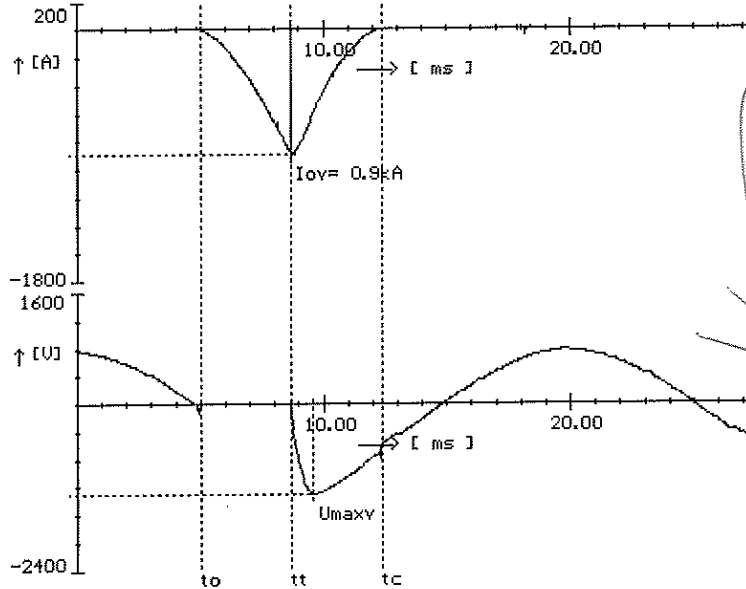

PV10g6, In = 20 A, dU = 80 mV, č.16

Záznam číslo 99991 ze dne 9. 6.2006

Nastavené hodnoty

Ip = 992.78 A
 Uef = 556 V
 cosφ = 0.24

Naměřené hodnoty

tt = 3.63 ms
 tc = 7.70 ms
 It = 900.00 A
 Io = 904.00 A
 Umax = 1272 V
 Uzot = 560 V
 I2tt = 748.78 A2s
 I2tc = 1690.63 A2s
 Alfa = 4 st.el.
 Psi = 69 st.el.
 It = 0.91 × Ip
 Ri = 9999.00 MOhm

I2091

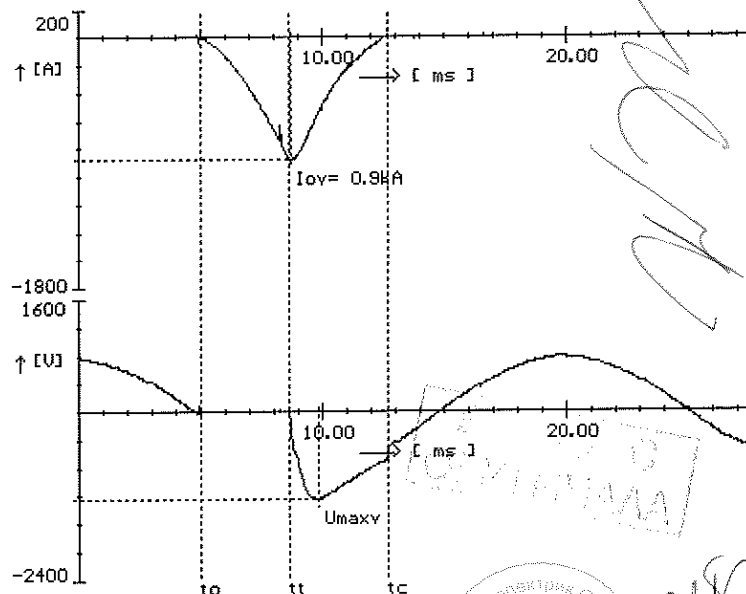

65

TEST REPORT

IEC 60269-1:98 3rd ed.+ Amd1:05; IEC 60269-2: 2nd ed.+ Amd1:95+ Amd2:01; IEC 60269-2-1:04 4th ed.

PU10g0, In = 12 A, dU = 91 mV, č.14

Záznam číslo 98503 ze dne 28. 3.2006

Nastavené hodnoty

Ip = 470.93 A
 Uef = 548 V
 cosφ = 0.27

Naměřené hodnoty

tt = 3.47 ms
 tc = 8.63 ms
 It = 462.00 A
 Io = 466.00 A
 Umax = 1520 V
 Uzot = 560 V
 I2tt = 208.28 A2s
 I2tc = 433.86 A2s
 Alfa = 0 st.el.
 Psi = 62 st.el.
 It = 0.98 × Ip
 Ri = 9999.00 MOhm

I2098

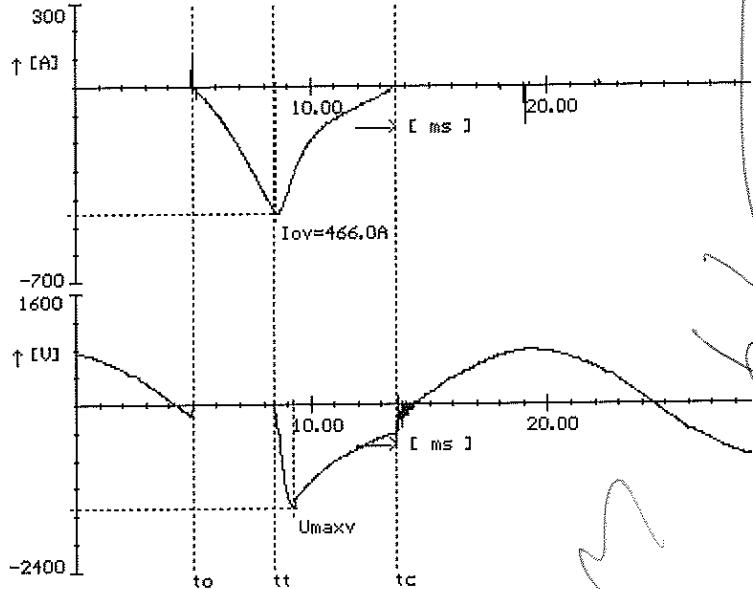

PU10g0, In = 12 A, dU = 91 mV, č.15

Záznam číslo 98504 ze dne 28. 3.2006

Nastavené hodnoty

Ip = 470.93 A
 Uef = 548 V
 cosφ = 0.27

Naměřené hodnoty

tt = 3.50 ms
 tc = 8.47 ms
 It = 472.00 A
 Io = 476.00 A
 Umax = 1544 V
 Uzot = 560 V
 I2tt = 253.17 A2s
 I2tc = 469.69 A2s
 Alfa = 1 st.el.
 Psi = 61 st.el.
 It = 1.00 × Ip
 Ri = 9999.00 MOhm

I2100

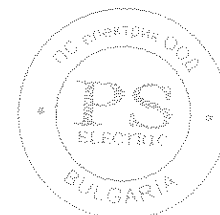
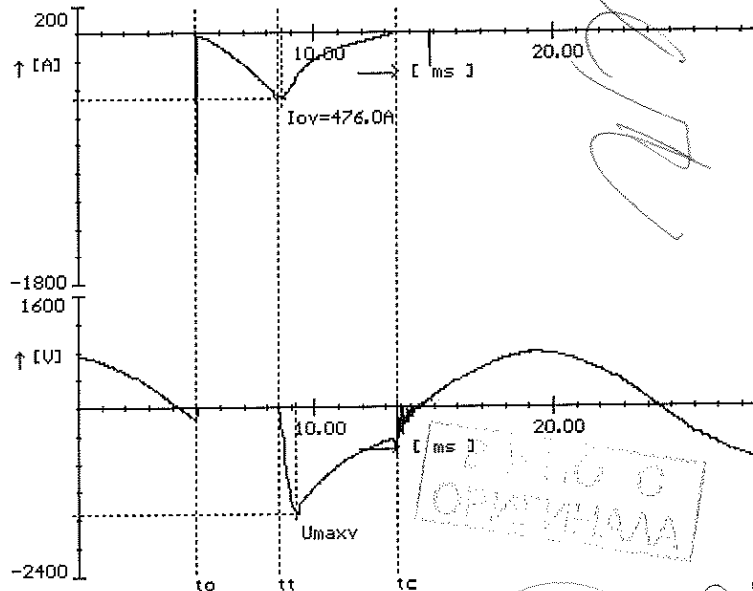

Handwritten signature

Handwritten signature

TEST REPORT

IEC 60269-1:98 3rd ed.+ Amd1:05; IEC 60269-2: 2nd ed.+ Amd1:95+ Amd2:01; IEC 60269-2-1:04 4th ed.

PU10gG, In = 12 A, dU = 90.5 mV, č.16

Záznam číslo 98505 ze dne 28. 3.2006

Nastavené hodnoty

Ip = 470.93 A
 Uef = 548 V
 cosφ = 0.27

Naměřené hodnoty

tt = 3.37 ms
 tc = 8.57 ms
 It = 462.00 A
 Io = 468.00 A
 Umax = 1504 V
 Uzot = 560 V
 I2tt = 205.10 A2s
 I2tc = 439.97 A2s
 Alfa = 1 st.el.
 Psi = 59 st.el.
 It = 0.98 × Ip
 Ri = 9999.00 MOhm

I2098

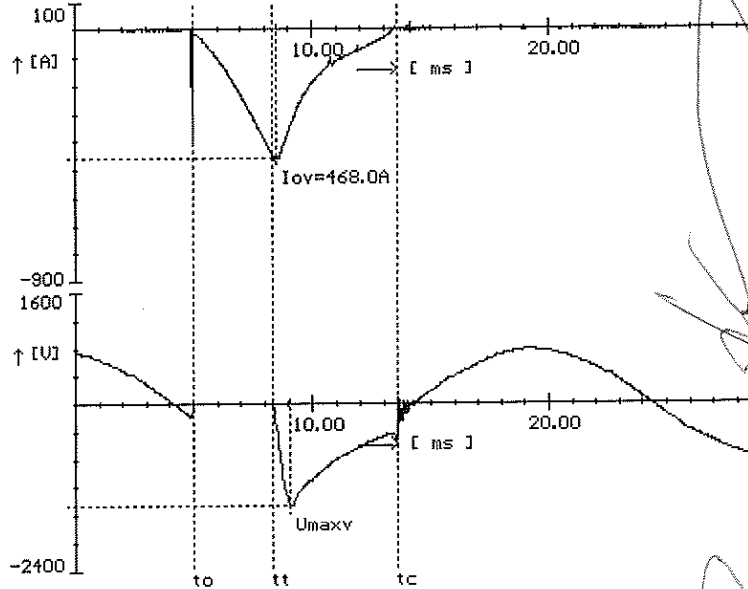

PU10gG, In = 6 A, dU = 118 mV, č.14.2

Záznam číslo 98519 ze dne 28. 3.2006

Nastavené hodnoty

Ip = 210.36 A
 Uef = 552 V
 cosφ = 0.27

Naměřené hodnoty

tt = 4.13 ms
 tc = 8.90 ms
 It = 209.00 A
 Io = 219.00 A
 Umax = 1408 V
 Uzot = 552 V
 I2tt = 44.06 A2s
 I2tc = 102.65 A2s
 Alfa = 1 st.el.
 Psi = 73 st.el.
 It = 0.99 × Ip
 Ri = 9999.00 MOhm

I2099

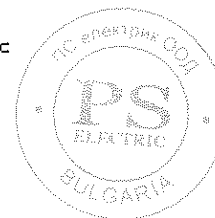
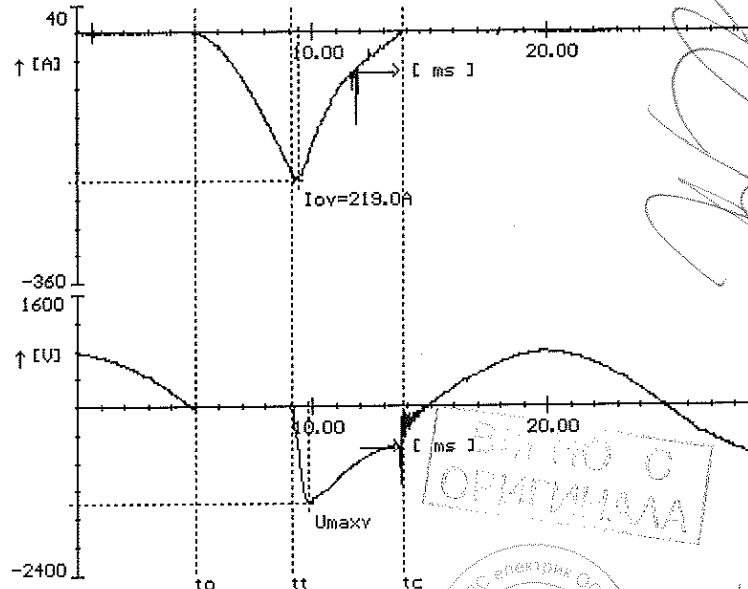

Handwritten signature

Handwritten signature

TEST REPORT

IEC 60269-1:98 3rd ed.+ Amd1:05; IEC 60269-2: 2nd ed.+ Amd1:95+ Amd2:01; IEC 60269-2-1:04 4th ed.

PV10g6, In = 6 A, dU = 118 mV, č.15

Záznam číslo 98520 ze dne 28. 3.2006

Nastavené hodnoty

Ip = 210.36 A
 Uef = 552 V
 cosφ = 0.27

Naměřené hodnoty

tt = 4.00 ms
 tc = 8.90 ms
 It = 190.00 A
 Io = 219.00 A
 Umax = 1400 V
 Uzot = 552 V
 I2tt = 50.76 A2s
 I2tc = 122.07 A2s
 Alfa = 0 st.el.
 Psi = 71 st.el.
 It = 0.90 × Ip
 Ri = 9999.00 MOhm

I2090

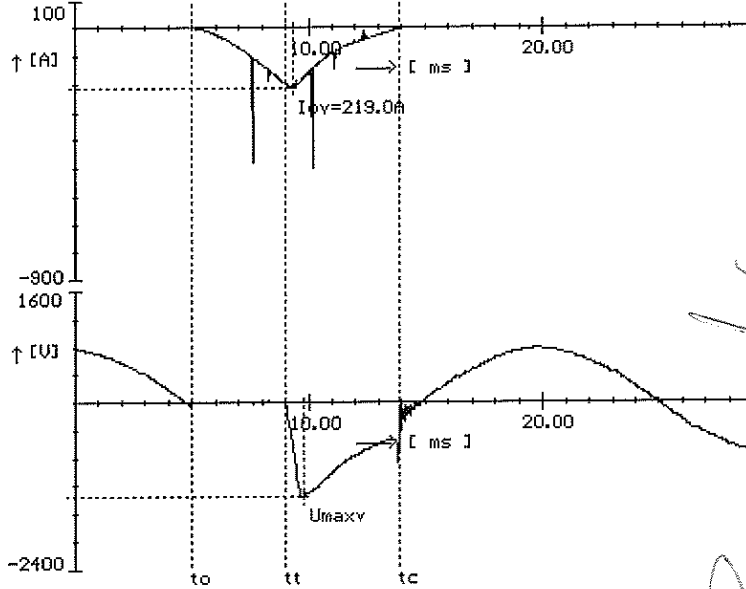

PV10g6, In = 6 A, dU = 118 mV, č.16

Záznam číslo 98521 ze dne 28. 3.2006

Nastavené hodnoty

Ip = 210.36 A
 Uef = 552 V
 cosφ = 0.27

Naměřené hodnoty

tt = 3.93 ms
 tc = 9.23 ms
 It = 211.00 A
 Io = 222.00 A
 Umax = 1272 V
 Uzot = 552 V
 I2tt = 44.93 A2s
 I2tc = 120.47 A2s
 Alfa = 0 st.el.
 Psi = 70 st.el.
 It = 1.00 × Ip
 Ri = 9999.00 MOhm

I2100

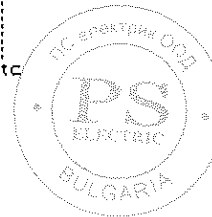
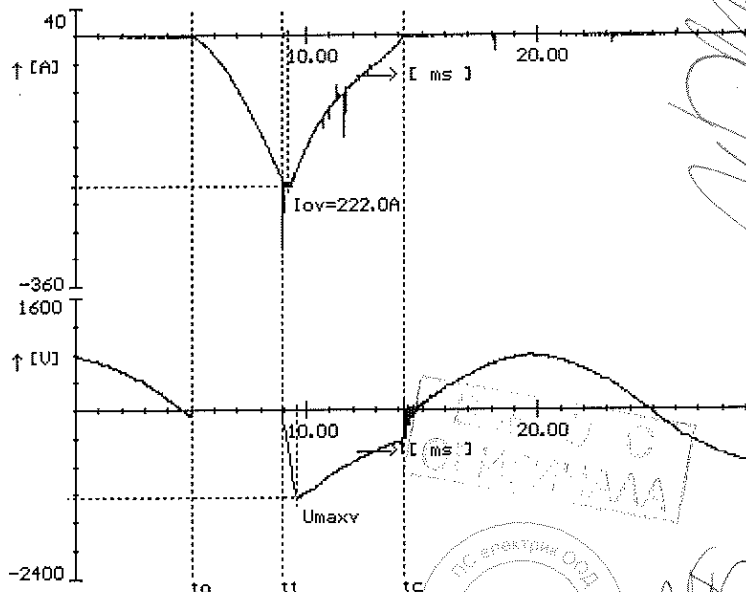

68

TEST REPORT

IEC 60269-1:98 3rd ed.+ Amd1:05; IEC 60269-2: 2nd ed.+ Amd1:95+ Amd2:01; IEC 60269-2-1:04 4th ed.

PV10g6, In = 4 A, dU = 210 mV, č.14.3

Záznam číslo 98527 ze dne 28. 3.2006

Nastavené hodnoty

Ip = 124.45 A
 Uef = 556 V
 cosφ = 0.26

Naměřené hodnoty

tt = 3.90 ms
 tc = 6.67 ms
 It = 122.00 A
 Io = 133.00 A
 Umax = 2416 V
 Uzot = 552 V
 I2tt = 23.08 A2s
 I2tc = 34.54 A2s
 Alfa = 0 st.el.
 Psi = 69 st.el.
 It = 0.98 × Ip
 Ri = 9999.00 MOhm

I2098

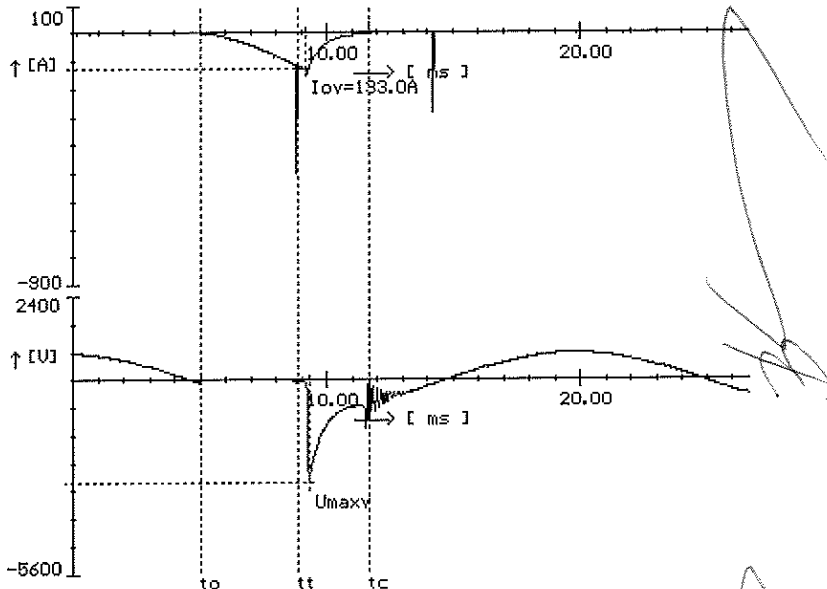

PV10g6, In = 4 A, dU = 209 mV, č.15

Záznam číslo 98528 ze dne 28. 3.2006

Nastavené hodnoty

Ip = 124.45 A
 Uef = 556 V
 cosφ = 0.26

Naměřené hodnoty

tt = 3.87 ms
 tc = 6.87 ms
 It = 121.00 A
 Io = 135.00 A
 Umax = 2404 V
 Uzot = 560 V
 I2tt = 15.03 A2s
 I2tc = 26.27 A2s
 Alfa = 0 st.el.
 Psi = 69 st.el.
 It = 0.97 × Ip
 Ri = 9999.00 MOhm

I2097

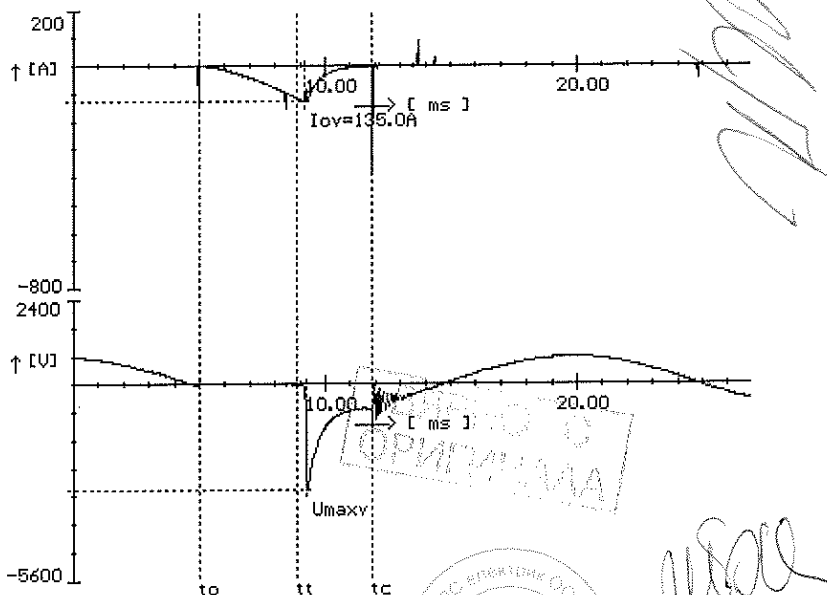

Handwritten signature

Handwritten signature

Handwritten signature

69

TEST REPORT

IEC 60269-1:98 3rd ed.+ Amd1:05; IEC 60269-2: 2nd ed.+ Amd1:95+ Amd2:01; IEC 60269-2-1:04 4th ed.

PV10g6, In = 4 A, dU = 208 mV, č.16

Záznam číslo 98529 ze dne 28. 3.2006

Nastavené hodnoty

Ip = 124.45 A
 Uef = 556 V
 cosφ = 0.26

Naměřené hodnoty

tt = 3.97 ms
 tc = 6.70 ms
 It = 121.00 A
 Io = 130.00 A
 Umax = 2528 V
 Uzot = 552 V
 I2tt = 14.40 A2s
 I2tc = 25.60 A2s
 Alfa = 1 st.el.
 Psi = 72 st.el.
 It = 0.97 x Ip
 Ri = 9999.00 MOhm

I2097

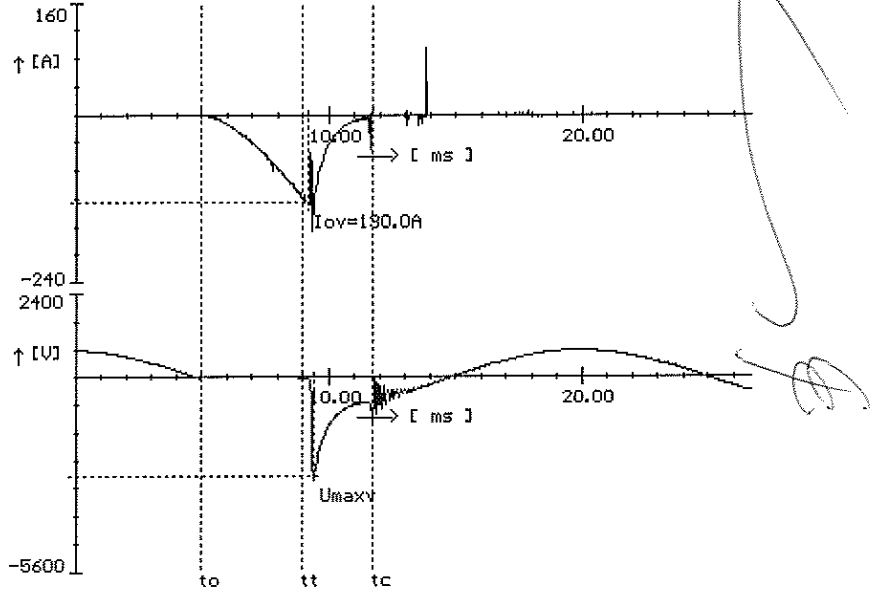

Handwritten signature

БАННО С
 ОПИТИТЕЛНА



Handwritten signature

Handwritten signature

Handwritten mark

TEST REPORT

IEC 60269-1:98 3rd ed.+ Amd1:05; IEC 60269-2: 2nd ed.+ Amd1:95+ Amd2:01; IEC 60269-2-1:04 4th ed.

PV10g6, In = 2 A, dU = 280 mV, č.14

Záznam číslo 98645 ze dne 5. 4.2006

Nastavené hodnoty

Ip = 12.83 A
 Uef = 188 V
 cosφ = 0.26

Naměřené hodnoty

tt = 9.90 ms
 tc = 11.03 ms
 It = 23.80 A
 Io = 25.80 A
 Umax = 1912 V
 Uzot = 192 V
 I2tt = 3.10 A2s
 I2tc = 3.30 A2s
 Alfa = 0 st.el.
 Psi = 177 st.el.
 It = 1.86 × Ip
 Ri = 9999.00 MOhm

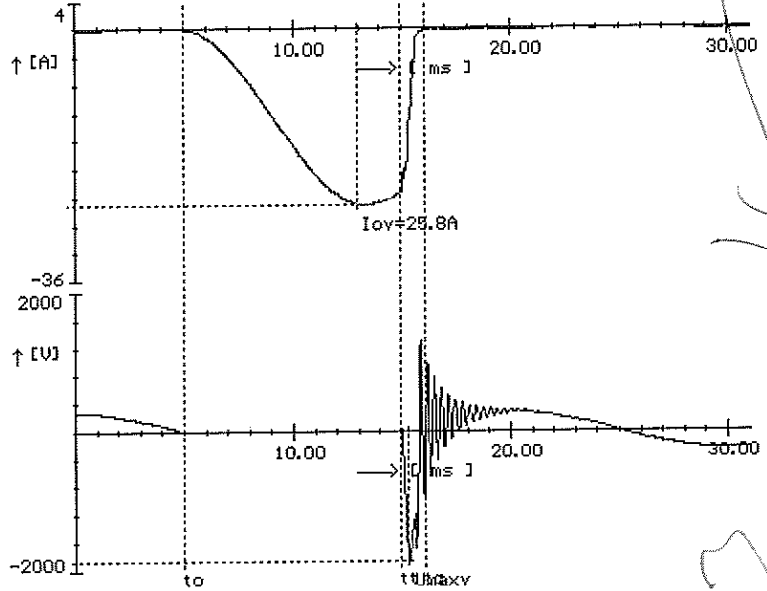

PV10g6, In = 2 A, dU = 281 mV, č.15

Záznam číslo 98646 ze dne 5. 4.2006

Nastavené hodnoty

Ip = 12.83 A
 Uef = 188 V
 cosφ = 0.26

Naměřené hodnoty

tt = 9.53 ms
 tc = 10.93 ms
 It = 24.40 A
 Io = 25.70 A
 Umax = 1848 V
 Uzot = 192 V
 I2tt = 2.89 A2s
 I2tc = 3.18 A2s
 Alfa = 0 st.el.
 Psi = 171 st.el.
 It = 1.90 × Ip
 Ri = 9999.00 MOhm

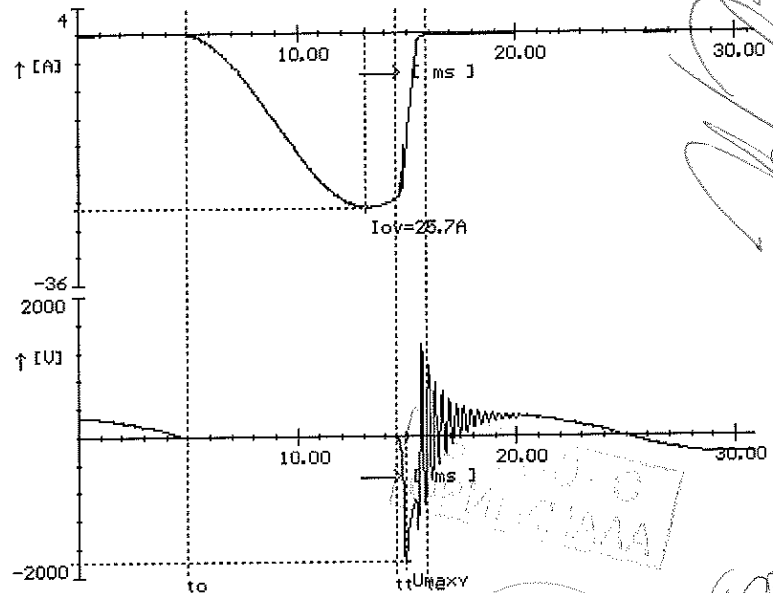

Handwritten signature and the number "41".

TEST REPORT

IEC 60269-1:98 3rd ed.+ Amd1:05; IEC 60269-2: 2nd ed.+ Amd1:95+ Amd2:01; IEC 60269-2-1:04 4th ed.

PV10g6, In = 2 A, dU = 261 mV, č.16

Záznam číslo 98651 ze dne 5. 4.2006

Nastavené hodnoty

Ip = 65.62 A
 Uef = 324 V
 cosφi = 0.25

Naměřené hodnoty

tt = 3.47 ms
 tc = 4.47 ms
 It = 52.00 A
 Io = 55.20 A
 Umax = 2512 V
 Uzot = 320 V
 I2tt = 2.38 A2s
 I2tc = 3.66 A2s
 Alfa = 7 st.el.
 Psi = 69 st.el.
 It = 0.79 x Ip
 Ri = 9999.00 MOhm

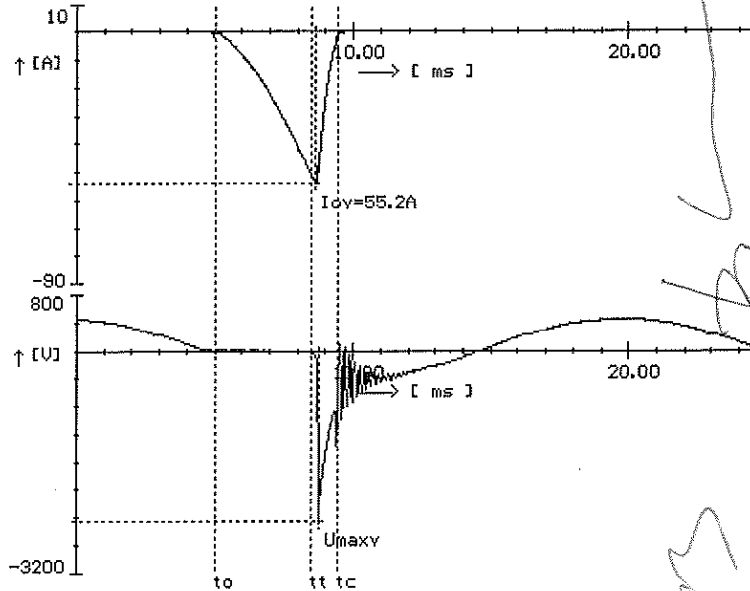

PV10g6, In = 2 A, dU = 262 mV, č.17

Záznam číslo 98652 ze dne 5. 4.2006

Nastavené hodnoty

Ip = 65.62 A
 Uef = 324 V
 cosφi = 0.25

Naměřené hodnoty

tt = 3.60 ms
 tc = 4.40 ms
 It = 52.40 A
 Io = 62.00 A
 Umax = 3000 V
 Uzot = 328 V
 I2tt = 2.36 A2s
 I2tc = 3.61 A2s
 Alfa = 0 st.el.
 Psi = 64 st.el.
 It = 0.80 x Ip
 Ri = 9999.00 MOhm

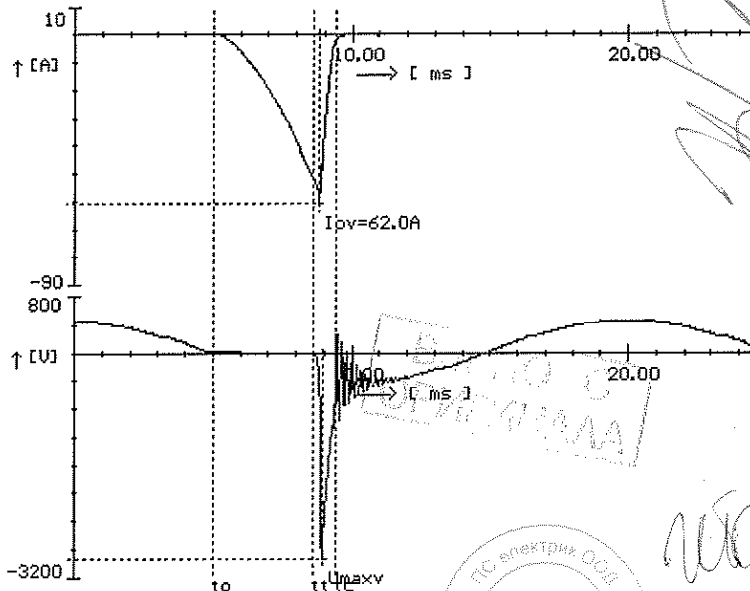

Handwritten signature

Handwritten signature

Handwritten number 72

TEST REPORT

IEC 60269-1:98 3rd ed.+ Amd1:05; IEC 60269-2: 2nd ed.+ Amd1:95+ Amd2:01; IEC 60269-2-1:04 4th ed.

PV10g0, I_n = 4 A, dU = 215 mV, č.20

Záznam číslo 98648 ze dne 5. 4.2006

Nastavené hodnoty

I_p = 34.47 A
 U_{ef} = 280 V
 cosφ = 0.29

Naměřené hodnoty

t_t = 9.37 ms
 t_c = 11.03 ms
 I_t = 66.00 A
 I_o = 68.00 A
 U_{max} = 1696 V
 U_{zot} = 288 V
 I_{2tt} = 19.27 A²s
 I_{2tc} = 21.50 A²s
 Alfa = 3 st.el.
 Psi = 171 st.el.
 I_t = 1.91 × I_p
 R_i = 9999.00 MOhm

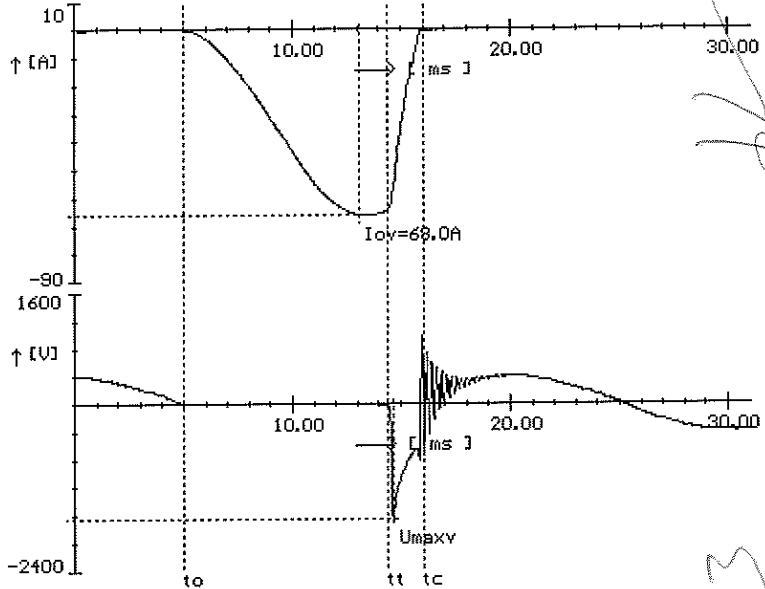

PV10g0, I_n = 4 A, dU = 216 mV, č.21

Záznam číslo 98649 ze dne 5. 4.2006

Nastavené hodnoty

I_p = 34.47 A
 U_{ef} = 280 V
 cosφ = 0.29

Naměřené hodnoty

t_t = 8.70 ms
 t_c = 10.93 ms
 I_t = 69.20 A
 I_o = 69.80 A
 U_{max} = 1568 V
 U_{zot} = 288 V
 I_{2tt} = 17.66 A²s
 I_{2tc} = 21.84 A²s
 Alfa = 1 st.el.
 Psi = 157 st.el.
 I_t = 2.01 × I_p
 R_i = 9999.00 MOhm

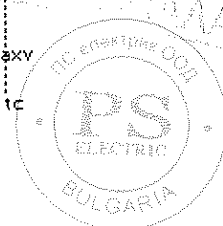
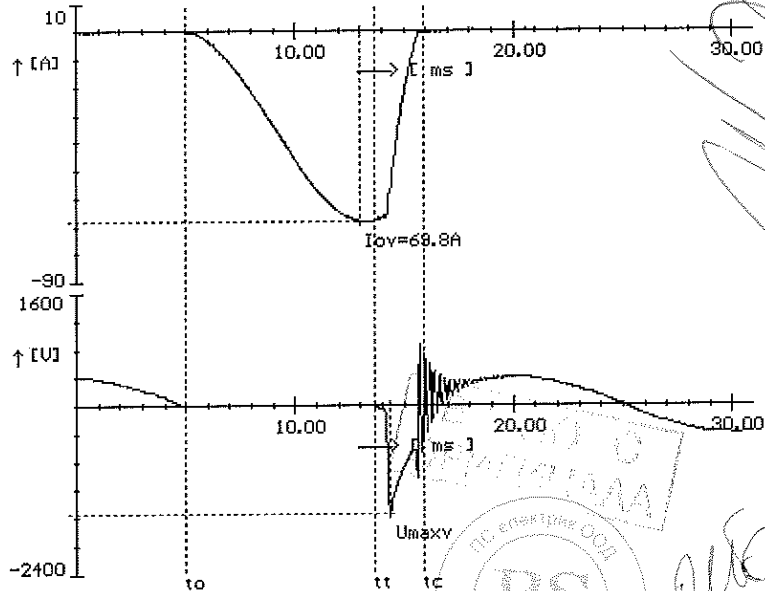

43

TEST REPORT

IEC 60269-1:98 3rd ed.+ Amd1:05; IEC 60269-2: 2nd ed.+ Amd1:95+ Amd2:01; IEC 60269-2-1:04 4th ed.

PV10g6, In = 4 A, dU = 200 mV, č.22

Záznam číslo 98661 ze dne 5. 4.2006

Nastavené hodnoty

Ip = 129,75 A
 Uef = 324 V
 cosφ = 0,27

Naměřené hodnoty

tt = 3,87 ms
 tc = 5,50 ms
 It = 120,00 A
 Io = 134,00 A
 Umax = 2192 V
 Uzot = 328 V
 I2tt = 13,98 A2s
 I2tc = 24,81 A2s
 Alfa = 5 st.el.
 Psi = 74 st.el.
 It = 0,92 × Ip
 Ri = 9999,00 MOhm

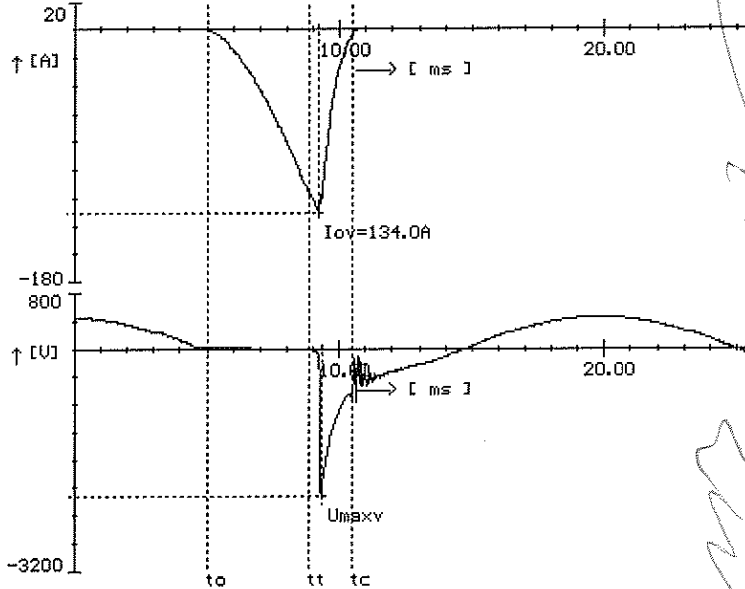

PV10g6, In = 4 A, dU = 213 mV, č.23

Záznam číslo 98662 ze dne 5. 4.2006

Nastavené hodnoty

Ip = 129,75 A
 Uef = 324 V
 cosφ = 0,27

Naměřené hodnoty

tt = 3,93 ms
 tc = 5,63 ms
 It = 125,00 A
 Io = 135,00 A
 Umax = 2200 V
 Uzot = 328 V
 I2tt = 15,84 A2s
 I2tc = 26,15 A2s
 Alfa = 4 st.el.
 Psi = 74 st.el.
 It = 0,96 × Ip
 Ri = 9999,00 MOhm

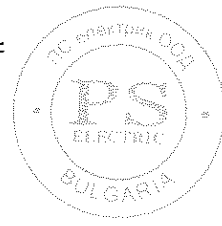
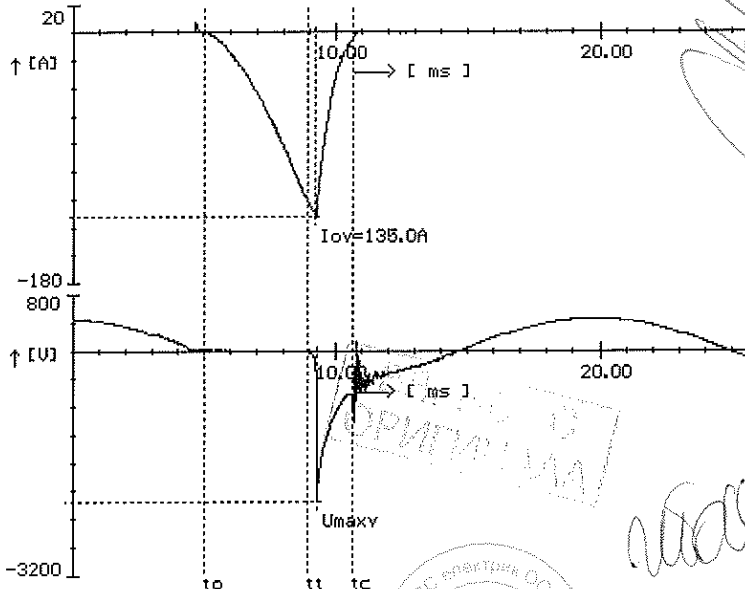

Handwritten mark '44' in the bottom right corner.

TEST REPORT

IEC 60269-1:98 3rd ed.+ Amd1:05; IEC 60269-2: 2nd ed.+ Amd1:95+ Amd2:01; IEC 60269-2-1:04 4th ed.

PV10g6, In = 6 A, dU = 120 mV, č. 20

Záznam číslo 98653 ze dne 5. 4.2006

Nastavené hodnoty

Ip = 65.62 A
 Uef = 324 V
 cosφ = 0.25

Naměřené hodnoty

tt = 8.07 ms
 tc = 11.07 ms
 It = 131.60 A
 Io = 131.60 A
 Umax = 1056 V
 Uzot = 328 V
 I2tt = 51.04 A2s
 I2tc = 72.14 A2s
 Alfa = 5 st.el.
 Psi = 149 st.el.
 It = 2.01 x Ip
 Ri = 9999.00 MOhm

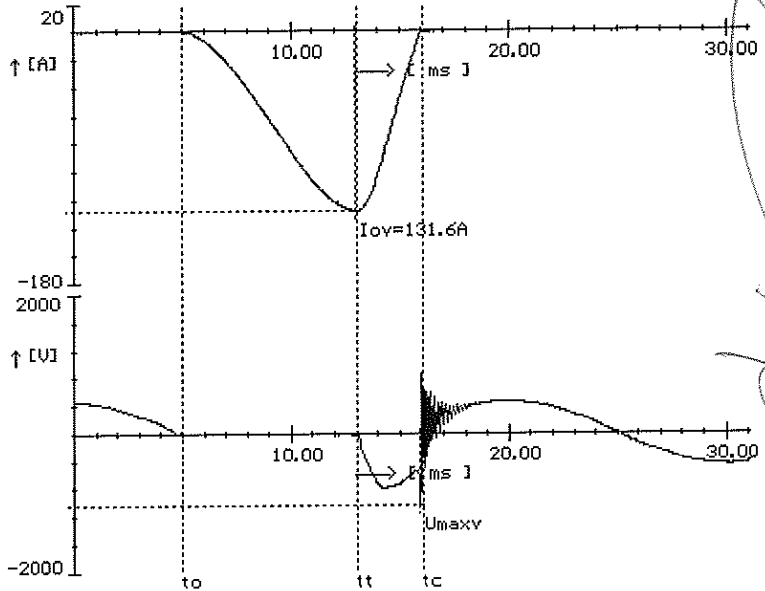

PV10g6, In = 6 A, dU = 126 mV, č. 21

Záznam číslo 98654 ze dne 5. 4.2006

Nastavené hodnoty

Ip = 65.62 A
 Uef = 324 V
 cosφ = 0.25

Naměřené hodnoty

tt = 8.27 ms
 tc = 11.07 ms
 It = 131.60 A
 Io = 132.40 A
 Umax = 872 V
 Uzot = 328 V
 I2tt = 53.49 A2s
 I2tc = 73.72 A2s
 Alfa = 2 st.el.
 Psi = 150 st.el.
 It = 2.01 x Ip
 Ri = 9999.00 MOhm

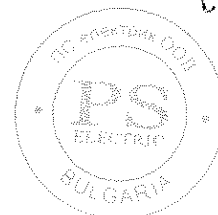
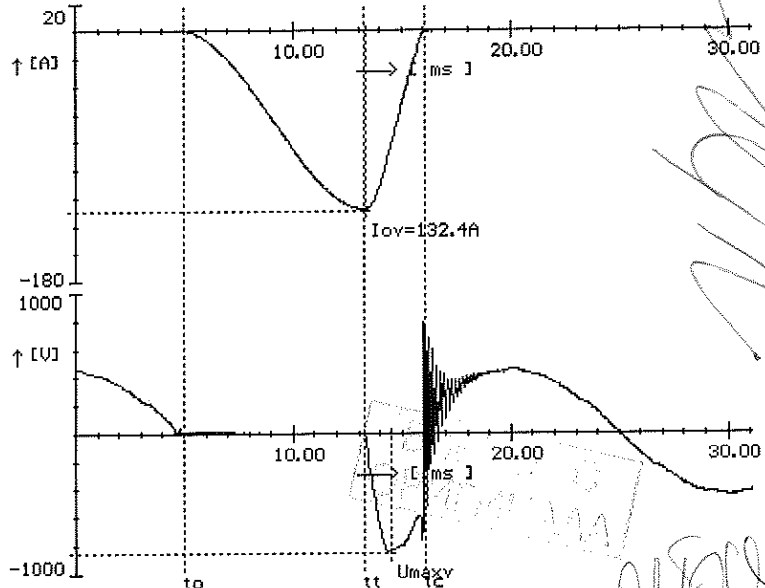

45

TEST REPORT

IEC 60269-1:98 3rd ed.+ Amd1:05; IEC 60269-2: 2nd ed.+ Amd1:95+ Amd2:01; IEC 60269-2-1:04 4th ed.

PV10g6, In = 6 A, dU = 113 mV, č.22

Záznam číslo 98671 ze dne 5. 4.2006

Nastavené hodnoty

Ip = 220.97 A
 Uef = 324 V
 cosφ = 0.23

Naměřené hodnoty

tt = 3.57 ms
 tc = 5.40 ms
 It = 178.00 A
 Io = 219.00 A
 Umax = 1376 V
 Uzot = 328 V
 I2tt = 26.52 A2s
 I2tc = 72.02 A2s
 Alfa = 8 st.el.
 Psi = 72 st.el.
 It = 0.81 x Ip
 Ri = 9999.00 MOhm

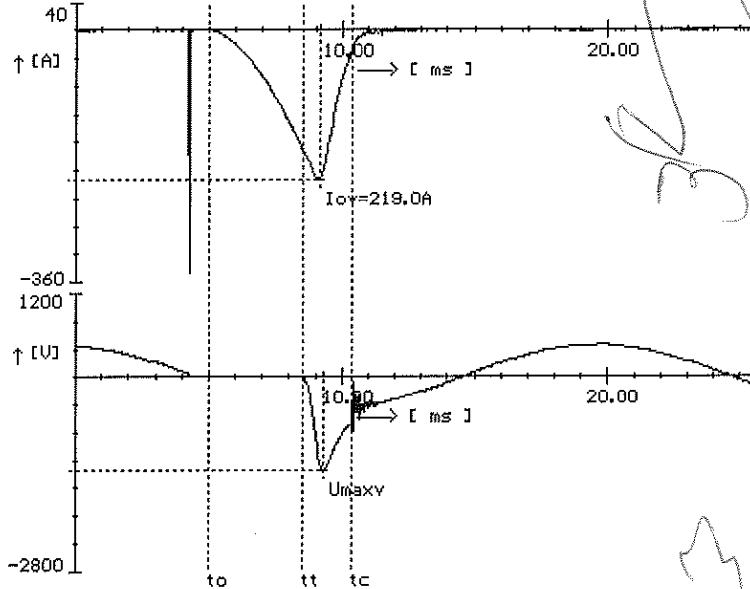

PV10g6, In = 6 A, dU = 113 mV, č.23

Záznam číslo 98672 ze dne 5. 4.2006

Nastavené hodnoty

Ip = 220.97 A
 Uef = 324 V
 cosφ = 0.23

Naměřené hodnoty

tt = 3.50 ms
 tc = 5.73 ms
 It = 168.00 A
 Io = 207.00 A
 Umax = 1288 V
 Uzot = 328 V
 I2tt = 22.50 A2s
 I2tc = 69.08 A2s
 Alfa = 7 st.el.
 Psi = 70 st.el.
 It = 0.76 x Ip
 Ri = 9999.00 MOhm

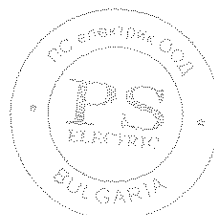
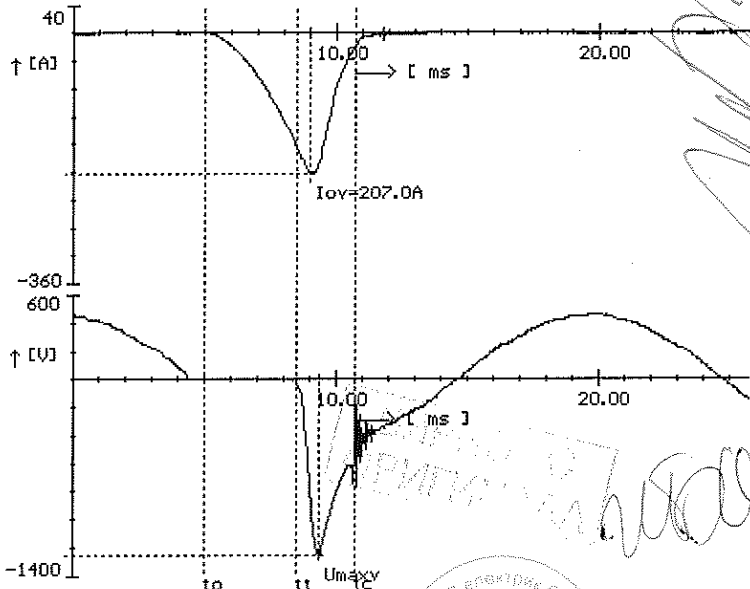

Handwritten mark

Handwritten mark

TEST REPORT

IEC 60269-1:98 3rd ed.+ Amd1:05; IEC 60269-2: 2nd ed.+ Amd1:95+ Amd2:01; IEC 60269-2-1:04 4th ed.

PV10g0, In = 8 A, dU = 108 mV, č.14

Záznam číslo 98658 ze dne 5. 4.2006

Nastavené hodnoty

Ip = 95.64 A
 Uef = 324 V
 cosφ = 0.23

Naměřené hodnoty

tt = 7.00 ms
 tc = 10.03 ms
 It = 182.00 A
 Io = 183.60 A
 Umax = 960 V
 Uzot = 328 V
 I2tt = 69.63 A2s
 I2tc = 113.24 A2s
 Alfa = 4 st.el.
 Psi = 129 st.el.
 It = 1.90 × Ip
 Ri = 9999.00 MOhm

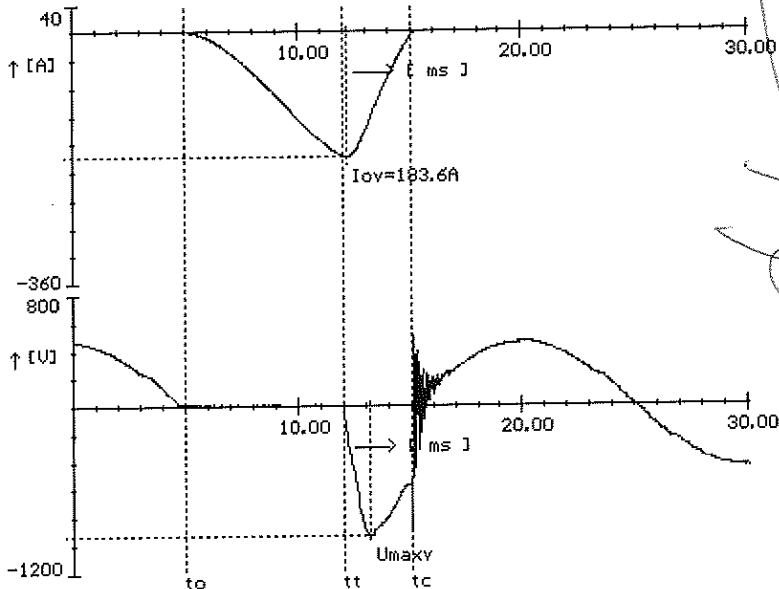

PV10g0, In = 8 A, dU = 108 mV, č.15

Záznam číslo 98659 ze dne 5. 4.2006

Nastavené hodnoty

Ip = 95.64 A
 Uef = 324 V
 cosφ = 0.23

Naměřené hodnoty

tt = 7.13 ms
 tc = 9.73 ms
 It = 182.00 A
 Io = 182.80 A
 Umax = 1152 V
 Uzot = 328 V
 I2tt = 69.99 A2s
 I2tc = 107.90 A2s
 Alfa = 0 st.el.
 Psi = 128 st.el.
 It = 1.90 × Ip
 Ri = 9999.00 MOhm

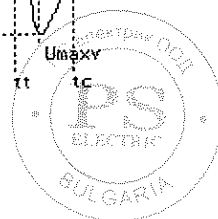
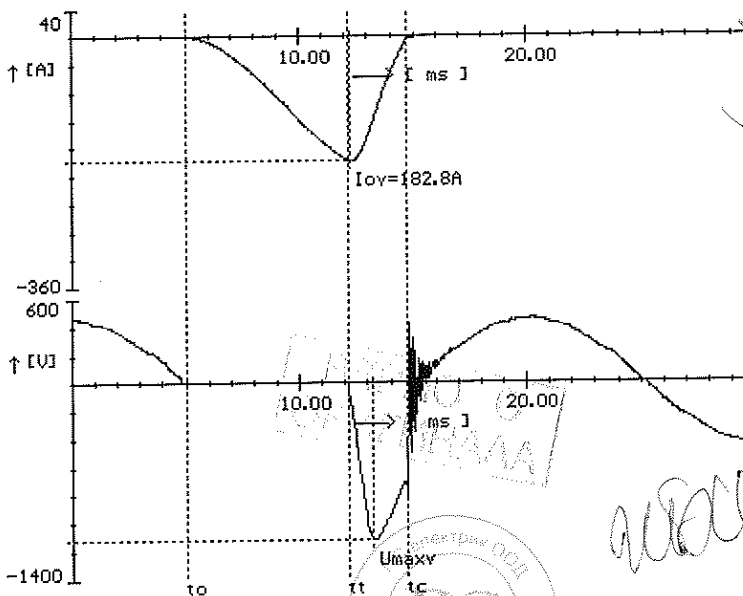

Handwritten signature

Handwritten signature

Handwritten signature

Handwritten signature

Handwritten signature

TEST REPORT

IEC 60269-1:98 3rd ed.+ Amd1:05; IEC 60269-2: 2nd ed.+ Amd1:95+ Amd2:01; IEC 60269-2-1:04 4th ed.

PV10gG, In = 8 A, dU = 101 mV, č. 16

Záznam číslo 98679 ze dne 5. 4.2006

Nastavené hodnoty

Ip = 315.20 A
 Uef = 324 V
 cosφ = 0.24

Naměřené hodnoty

tt = 3.47 ms
 tc = 5.07 ms
 It = 226.00 A
 Io = 264.00 A
 Umax = 1248 V
 Uzot = 328 V
 I2tt = 38.73 A2s
 I2tc = 93.50 A2s
 Alfa = 4 st.el.
 Psi = 66 st.el.
 It = 0.72 x Ip
 Ri = 9999.00 MOhm

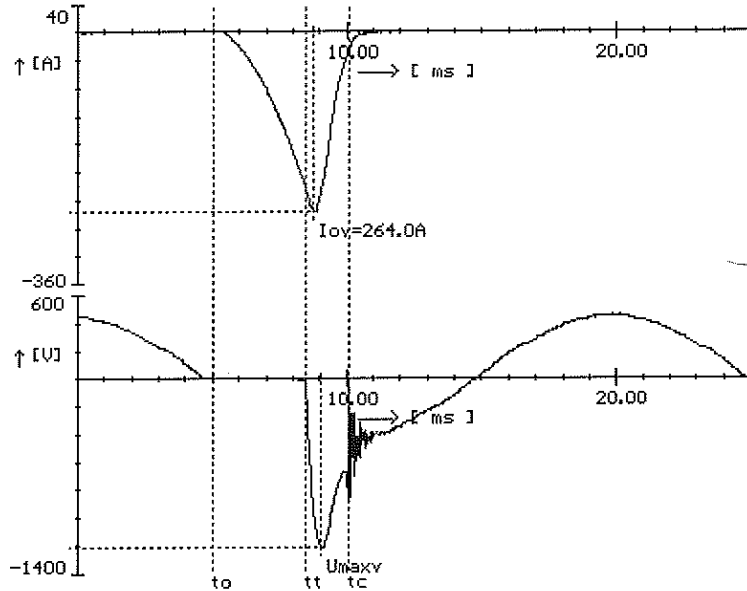

PV10gG, In = 8 A, dU = 101 mV, č. 17

Záznam číslo 98680 ze dne 5. 4.2006

Nastavené hodnoty

Ip = 315.20 A
 Uef = 324 V
 cosφ = 0.24

Naměřené hodnoty

tt = 3.20 ms
 tc = 4.77 ms
 It = 226.00 A
 Io = 268.00 A
 Umax = 1296 V
 Uzot = 328 V
 I2tt = 39.01 A2s
 I2tc = 96.98 A2s
 Alfa = 10 st.el.
 Psi = 67 st.el.
 It = 0.72 x Ip
 Ri = 9999.00 MOhm

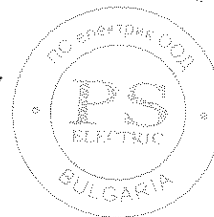
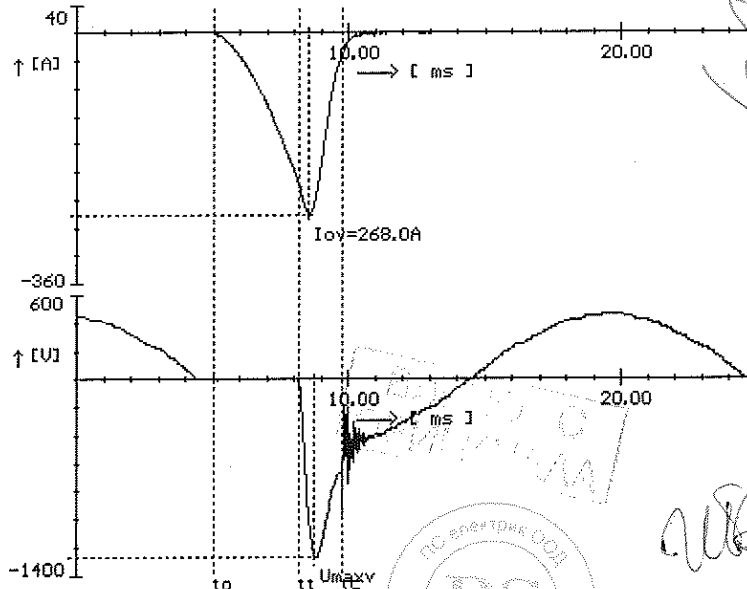

Handwritten signature

Handwritten signature

Handwritten signature

Handwritten signature

48

TEST REPORT

IEC 60269-1:98 3rd ed.+ Amd1:05; IEC 60269-2: 2nd ed.+ Amd1:95+ Amd2:01; IEC 60269-2-1:04 4th ed.

PV10g6, I_n = 10 A, dU = 104 mV, č.8

Záznam číslo 98663 ze dne 5. 4.2006

Nastavené hodnoty

Ip	=	129.75	A
Uef	=	324	V
cosφi	=	0.27	
Naměřené hodnoty			
tt	=	6.77	ms
tc	=	9.53	ms
It	=	241.00	A
Io	=	242.00	A
Umax	=	1040	V
Uzot	=	328	V
I2tt	=	121.86	A2s
I2tc	=	187.93	A2s
Alfa	=	3	st.el.
Psi	=	124	st.el.
It	=	1.86 × Ip	
Ri	=	9999.00	MΩm

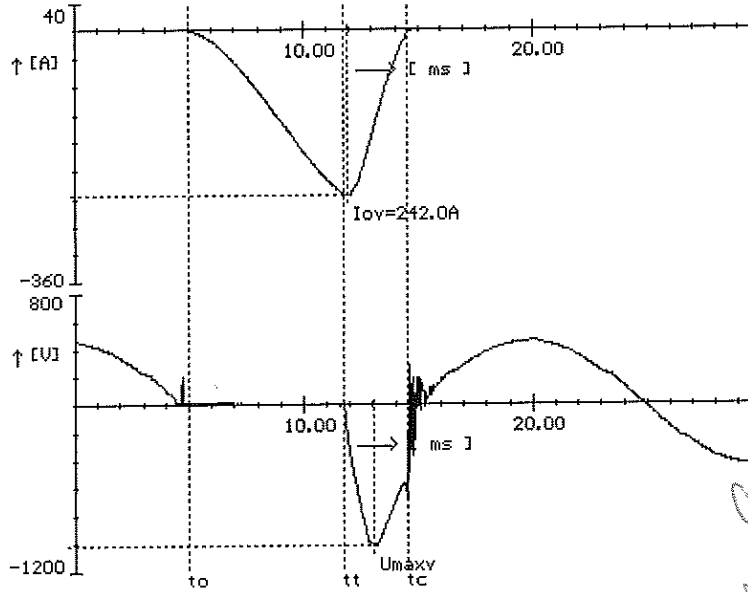

PV10g6, I_n = 10 A, dU = 104 mV, č.9

Záznam číslo 98664 ze dne 5. 4.2006

Nastavené hodnoty

Ip	=	129.75	A
Uef	=	324	V
cosφi	=	0.27	
Naměřené hodnoty			
tt	=	6.87	ms
tc	=	9.60	ms
It	=	241.00	A
Io	=	242.00	A
Umax	=	1128	V
Uzot	=	328	V
I2tt	=	123.57	A2s
I2tc	=	188.95	A2s
Alfa	=	2	st.el.
Psi	=	125	st.el.
It	=	1.86 × Ip	
Ri	=	9999.00	MΩm

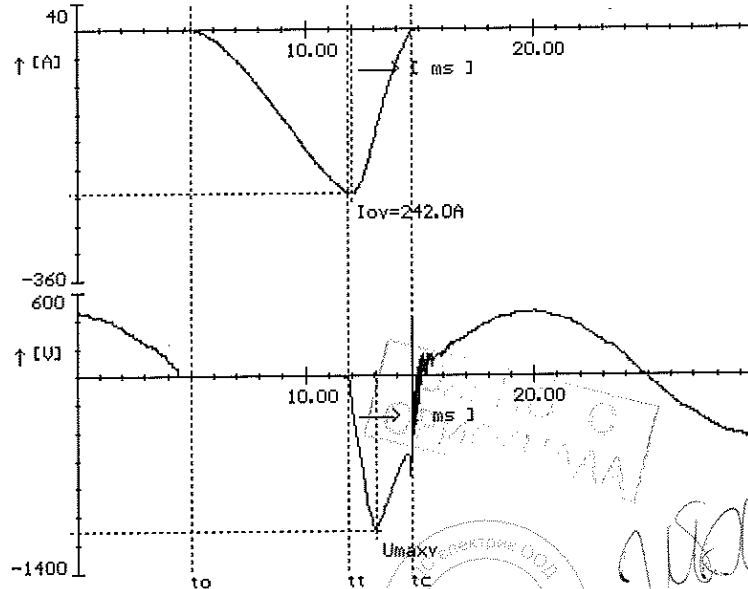

49

TEST REPORT

IEC 60269-1:98 3rd ed.+ Amd1:05; IEC 60269-2: 2nd ed.+ Amd1:95+ Amd2:01; IEC 60269-2-1:04 4th ed.

PV10g6, In = 10 A, dU = 96 mV, č.10

Záznam číslo 98682 ze dne 5. 4.2006

Nastavené hodnoty

Ip = 403.76 A
 Uef = 320 V
 cosφ = 0.25

Naměřené hodnoty

tt = 3.40 ms
 tc = 5.70 ms
 It = 286.00 A
 Io = 356.00 A
 Umax = 1192 V
 Uzot = 328 V
 I2tt = 62.61 A2s
 I2tc = 175.38 A2s
 Alfa = 8 st.el.
 Psi = 69 st.el.
 It = 0.71 x Ip
 Ri = 9999.00 MOhm

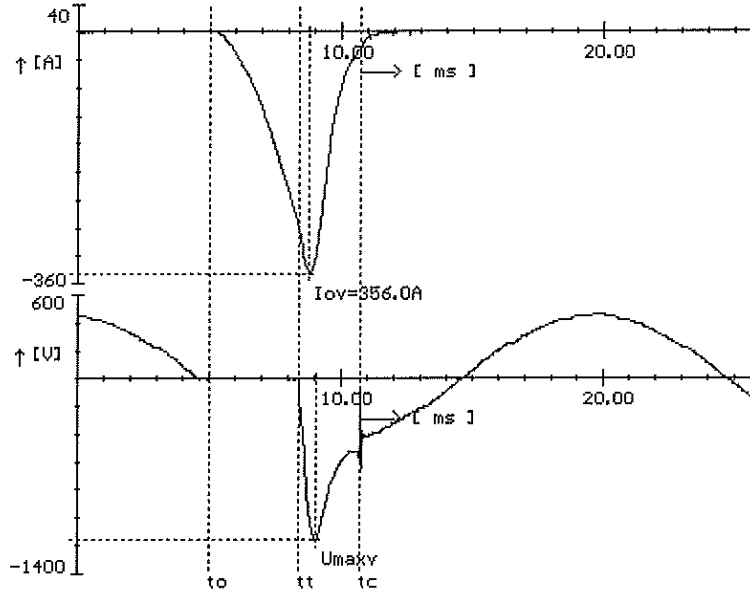

PV10g6, In = 10 A, dU = 96.5 mV, č.11

Záznam číslo 98683 ze dne 5. 4.2006

Nastavené hodnoty

Ip = 403.76 A
 Uef = 320 V
 cosφ = 0.25

Naměřené hodnoty

tt = 3.50 ms
 tc = 5.77 ms
 It = 300.00 A
 Io = 370.00 A
 Umax = 1296 V
 Uzot = 320 V
 I2tt = 67.93 A2s
 I2tc = 178.13 A2s
 Alfa = 7 st.el.
 Psi = 70 st.el.
 It = 0.74 x Ip
 Ri = 9999.00 MOhm

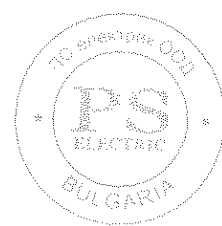
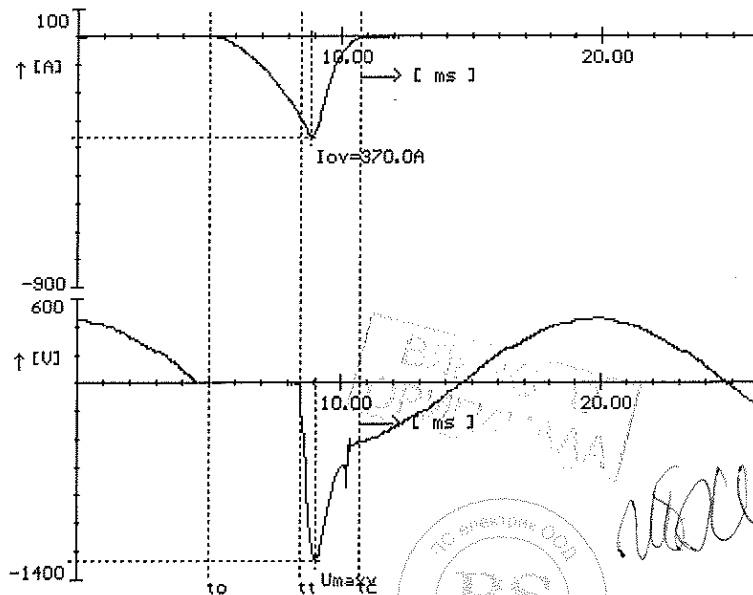

Handwritten signature

Handwritten signature

80

TEST REPORT

IEC 60269-1:98 3rd ed.+ Amd1:05; IEC 60269-2: 2nd ed.+ Amd1:95+ Amd2:01; IEC 60269-2-1:04 4th ed.

PV10g6, I_n = 12 A, dU = 94.6 mV, č.20

Záznam číslo 98668 ze dne 5. 4.2006

Nastavené hodnoty

I_p = 174.66 A
 U_{ef} = 324 V
 cosφ = 0.26

Naměřené hodnoty

t_t = 6.83 ms
 t_c = 9.67 ms
 I_t = 325.00 A
 I_o = 327.00 A
 U_{max} = 1184 V
 U_{zot} = 328 V
 I_{2tt} = 220.17 A²s
 I_{2tc} = 334.06 A²s
 Alfa = 5 st.el.
 Psi = 127 st.el.
 I_t = 1.86 × I_p
 R_i = 9999.00 MOhm

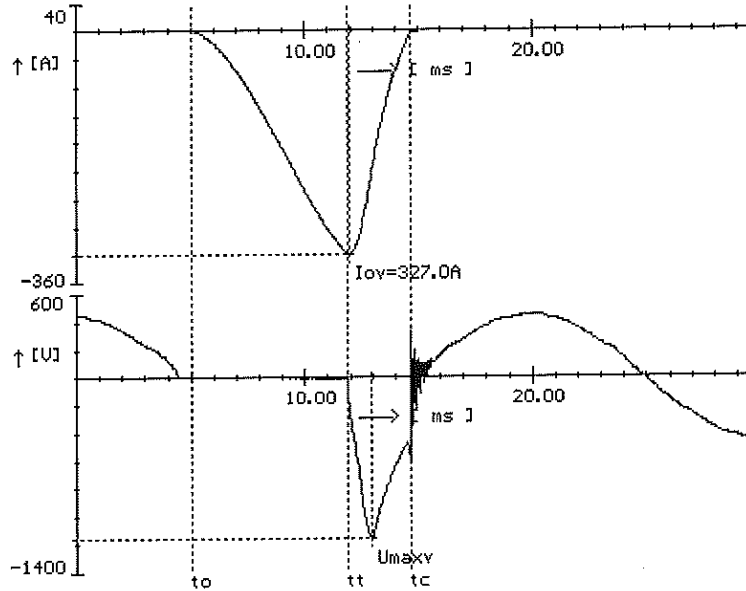

PV10g6, I_n = 12 A, dU = 94 mV, č.21

Záznam číslo 98669 ze dne 5. 4.2006

Nastavené hodnoty

I_p = 174.66 A
 U_{ef} = 324 V
 cosφ = 0.26

Naměřené hodnoty

t_t = 6.93 ms
 t_c = 9.73 ms
 I_t = 324.00 A
 I_o = 325.00 A
 U_{max} = 1160 V
 U_{zot} = 320 V
 I_{2tt} = 220.73 A²s
 I_{2tc} = 330.36 A²s
 Alfa = 0 st.el.
 Psi = 124 st.el.
 I_t = 1.86 × I_p
 R_i = 9999.00 MOhm

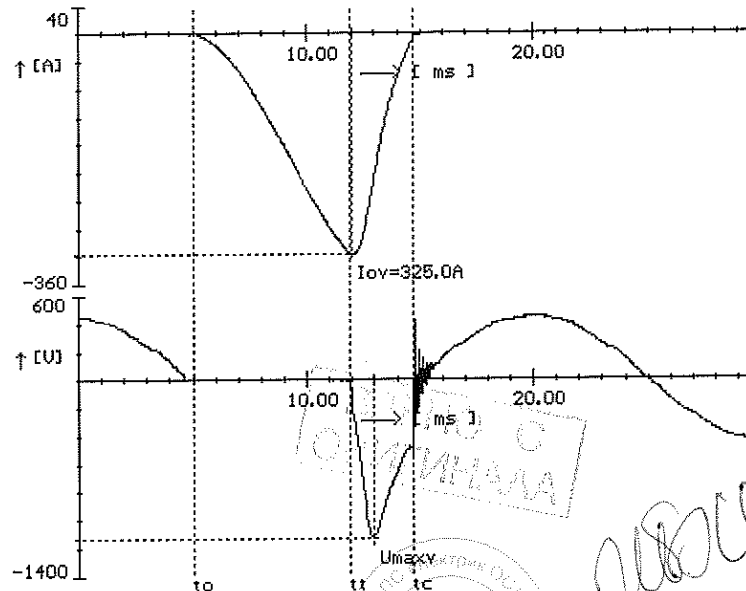

Handwritten signature or scribble on the right side of the page.

Handwritten signature or scribble below the stamp.

TEST REPORT

IEC 60269-1:98 3rd ed.+ Amd1:05; IEC 60269-2: 2nd ed.+ Amd1:95+ Amd2:01; IEC 60269-2-1:04 4th ed.

PU10g6, In = 12 A, dU = 86.5 mV, č.22

Záznam číslo 98689 ze dne 5. 4.2006

Nastavené hodnoty

Ip = 450.77 A
 Uef = 320 V
 cosφf = 0.25

Naměřené hodnoty

tt = 3.63 ms
 tc = 5.77 ms
 It = 386.00 A
 Io = 474.00 A
 Umax = 1384 V
 Uzot = 328 V
 I2tt = 131.60 A2s
 I2tc = 316.63 A2s
 Alfa = 11 st.el.
 Psi = 76 st.el.
 It = 0.86 × Ip
 Ri = 9999.00 MOhm

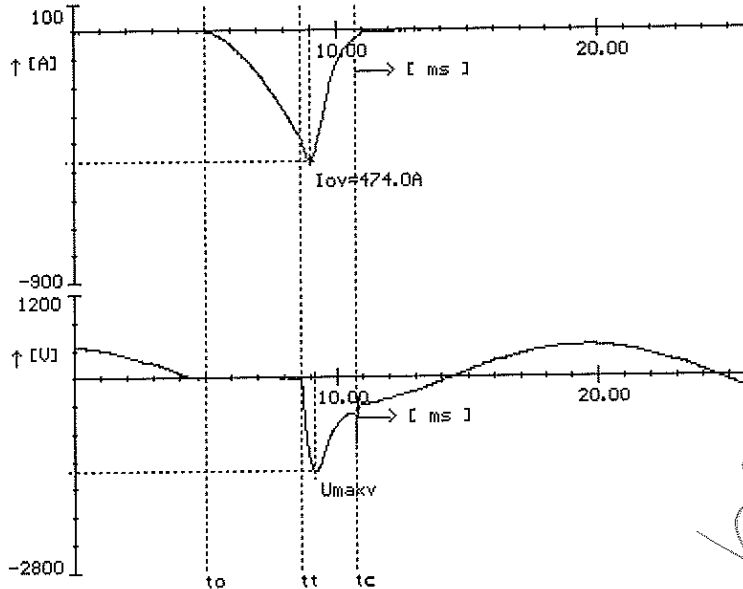

PU10g6, In = 12 A, dU = 86.5 mV, č.23

Záznam číslo 98690 ze dne 5. 4.2006

Nastavené hodnoty

Ip = 450.77 A
 Uef = 320 V
 cosφf = 0.25

Naměřené hodnoty

tt = 3.90 ms
 tc = 5.93 ms
 It = 392.00 A
 Io = 474.00 A
 Umax = 1384 V
 Uzot = 328 V
 I2tt = 136.93 A2s
 I2tc = 315.05 A2s
 Alfa = 6 st.el.
 Psi = 76 st.el.
 It = 0.87 × Ip
 Ri = 9999.00 MOhm

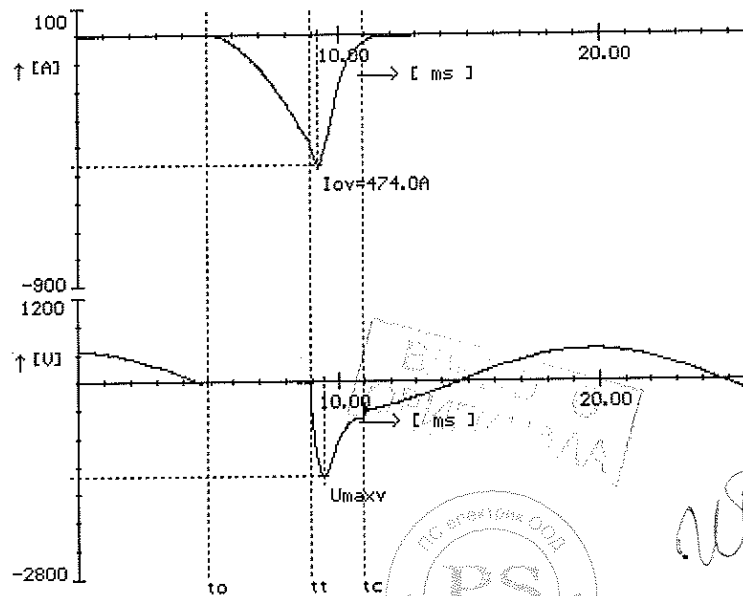

[Handwritten signature]

[Handwritten signature]

[Handwritten signature]

[Handwritten signature]

TEST REPORT

IEC 60269-1:98 3rd ed.+ Amd1:05; IEC 60269-2: 2nd ed.+ Amd1:95+ Amd2:01; IEC 60269-2-1:04 4th ed.

PV10g6, In = 16 A, dU = 89 mV, č.14

Záznam číslo 99982 ze dne 8. 6.2006

Nastavené hodnoty

Ip = 278.25 A
 Uef = 324 V
 cosφ = 0.24

Naměřené hodnoty

tt = 6.17 ms
 tc = 9.40 ms
 It = 492.00 A
 Io = 498.00 A
 Umax = 896 V
 Uzot = 328 V
 I2tt = 448.24 A2s
 I2tc = 781.96 A2s
 Alfa = 2 st.el.
 Psi = 112 st.el.
 It = 1.77 x Ip
 Ri = 9999.00 MOhm

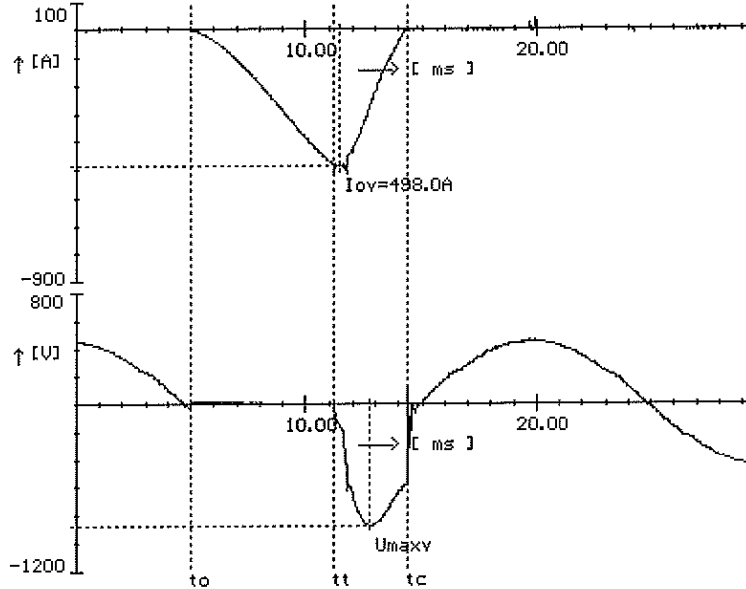

PV10g6, In = 16 A, dU = 89 mV, č.15

Záznam číslo 99983 ze dne 8. 6.2006

Nastavené hodnoty

Ip = 278.25 A
 Uef = 324 V
 cosφ = 0.24

Naměřené hodnoty

tt = 6.33 ms
 tc = 9.53 ms
 It = 488.00 A
 Io = 488.00 A
 Umax = 888 V
 Uzot = 320 V
 I2tt = 429.26 A2s
 I2tc = 747.69 A2s
 Alfa = 0 st.el.
 Psi = 114 st.el.
 It = 1.75 x Ip
 Ri = 9999.00 MOhm

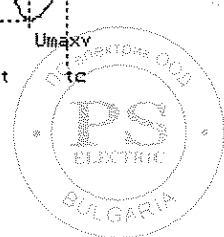
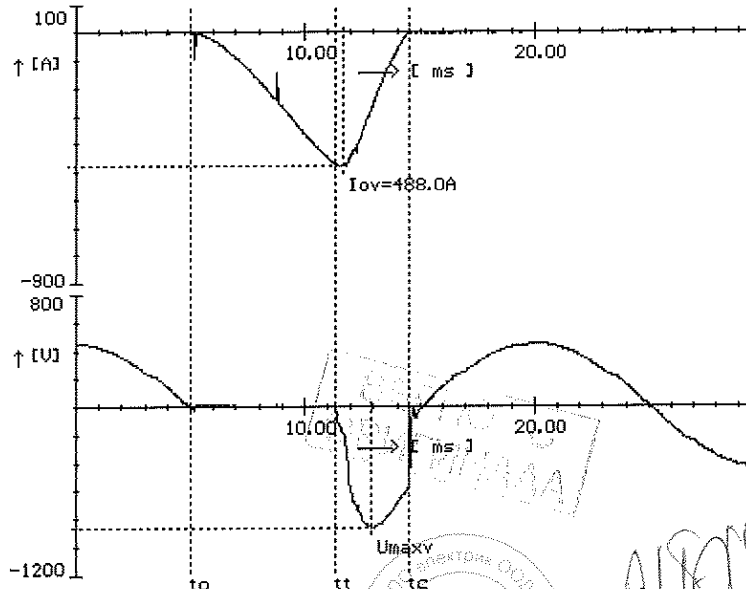

Handwritten signature and scribbles on the right side of the page.

Handwritten signature.

83

Handwritten signature at the bottom left.

TEST REPORT

IEC 60269-1:98 3rd ed.+ Amd1:05; IEC 60269-2: 2nd ed.+ Amd1:95+ Amd2:01; IEC 60269-2-1:04 4th ed.

PV10g0, In = 16 A, dU = 84 mV, č.16

Záznam číslo 99977 ze dne 8. 6.2006

Nastavené hodnoty

Ip = 543.77 A
 Uef = 320 V
 cosφ = 0.23

Naměřené hodnoty

tt = 4.40 ms
 tc = 6.87 ms
 It = 636.00 A
 Io = 640.00 A
 Umax = 1024 V
 Uzot = 320 V
 I2tt = 456.46 A2s
 I2tc = 761.03 A2s
 Alfa = 3 st.el.
 Psi = 82 st.el.
 It = 1.17 × Ip
 Ri = 9999.00 MOhm

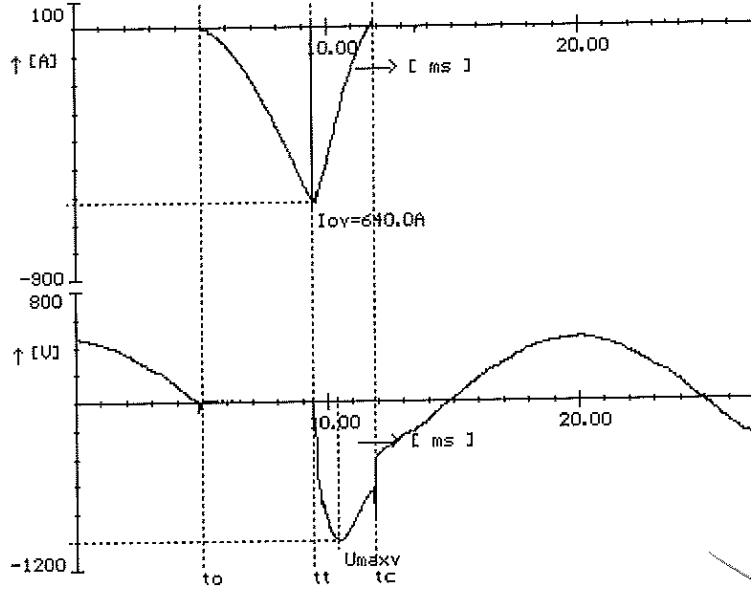

PV10g0, In = 16 A, dU = 85 mV, č.17

Záznam číslo 99978 ze dne 8. 6.2006

Nastavené hodnoty

Ip = 543.77 A
 Uef = 320 V
 cosφ = 0.23

Naměřené hodnoty

tt = 4.20 ms
 tc = 6.73 ms
 It = 624.00 A
 Io = 632.00 A
 Umax = 1032 V
 Uzot = 320 V
 I2tt = 429.80 A2s
 I2tc = 752.26 A2s
 Alfa = 5 st.el.
 Psi = 80 st.el.
 It = 1.15 × Ip
 Ri = 9999.00 MOhm

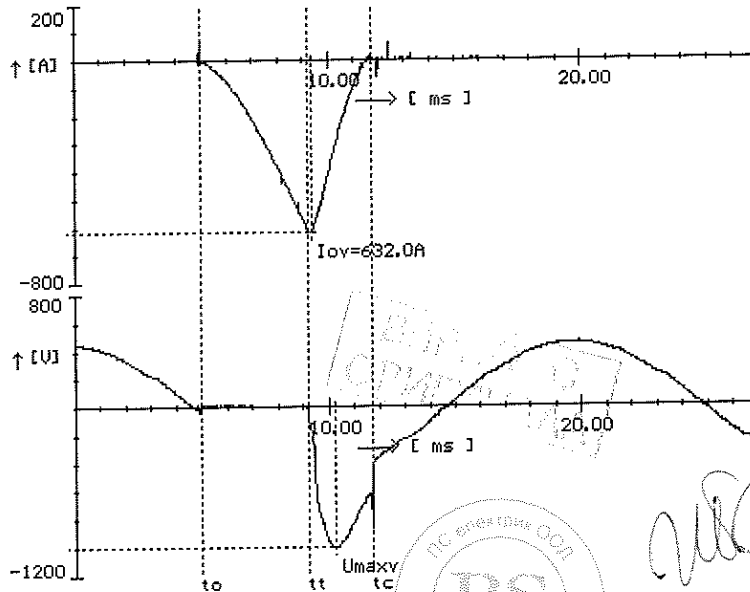

[Handwritten signature]

[Handwritten signature]

[Handwritten signature]

84

[Handwritten mark]

TEST REPORT

IEC 60269-1:98 3rd ed.+ Amd1:05; IEC 60269-2: 2nd ed.+ Amd1:95+ Amd2:01; IEC 60269-2-1:04 4th ed.

PV10g6, In = 20 A, dU = 80 mV, č.20

Záznam číslo 99980 ze dne 8. 6.2006

Nastavené hodnoty

Ip = 408.00 A
 Uef = 320 V
 cosφ = 0.24

Naměřené hodnoty

tt = 5.87 ms
 tc = 9.17 ms
 It = 672.00 A
 Io = 682.00 A
 Umax = 920 V
 Uzot = 320 V
 I2tt = 740.98 A2s
 I2tc = 1326.57 A2s
 Alfa = 1 st.el.
 Psi = 106 st.el.
 It = 1.65 × Ip
 Ri = 9999.00 MOhm

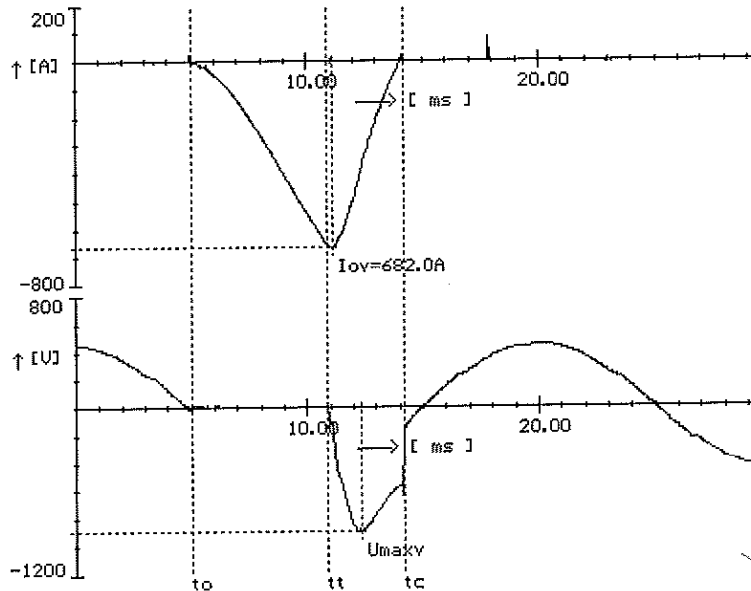

PV10g6, In = 20 A, dU = 80.5 mV, č.21

Záznam číslo 99981 ze dne 8. 6.2006

Nastavené hodnoty

Ip = 408.00 A
 Uef = 320 V
 cosφ = 0.24

Naměřené hodnoty

tt = 5.73 ms
 tc = 9.07 ms
 It = 672.00 A
 Io = 684.00 A
 Umax = 936 V
 Uzot = 320 V
 I2tt = 748.83 A2s
 I2tc = 1356.44 A2s
 Alfa = 4 st.el.
 Psi = 107 st.el.
 It = 1.65 × Ip
 Ri = 9999.00 MOhm

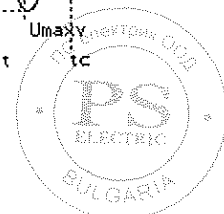
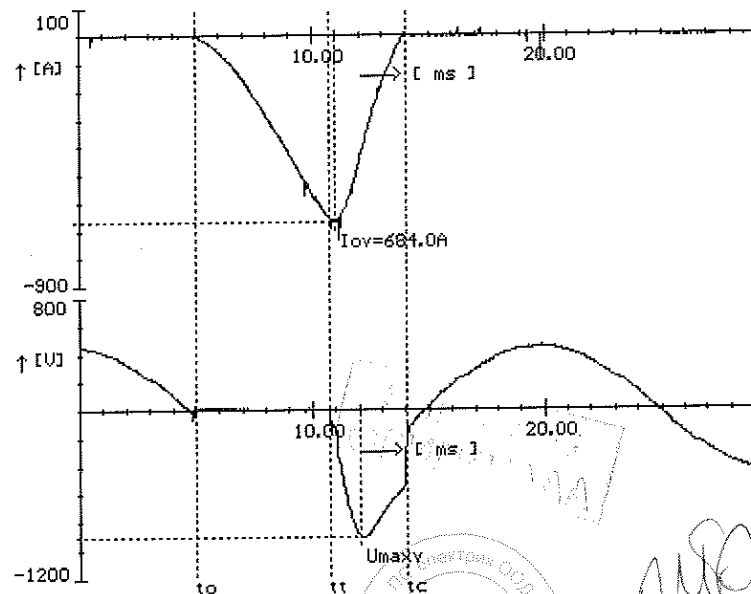

[Handwritten signature]

[Handwritten signature]

85

[Handwritten signature]

TEST REPORT

IEC 60269-1:98 3rd ed.+ Amd1:05; IEC 60269-2: 2nd ed.+ Amd1:95+ Amd2:01; IEC 60269-2-1:04 4th ed.

PV10gG, In = 20 A, dU = 79 mV, č.22

Záznam číslo 99972 ze dne 8. 6.2006

Nastavené hodnoty

Ip = 793.37 A
 Uef = 332 V
 cosφ = 0.28

Naměřené hodnoty

tt = 3.93 ms
 tc = 6.40 ms
 It = 848.00 A
 Io = 864.00 A
 Umax = 1032 V
 Uzot = 344 V
 I2tt = 747.55 A2s
 I2tc = 1263.84 A2s
 Alfa = 6 st.el.
 Psi = 76 st.el.
 It = 1.07 × Ip
 Ri = 9999.00 MOhm

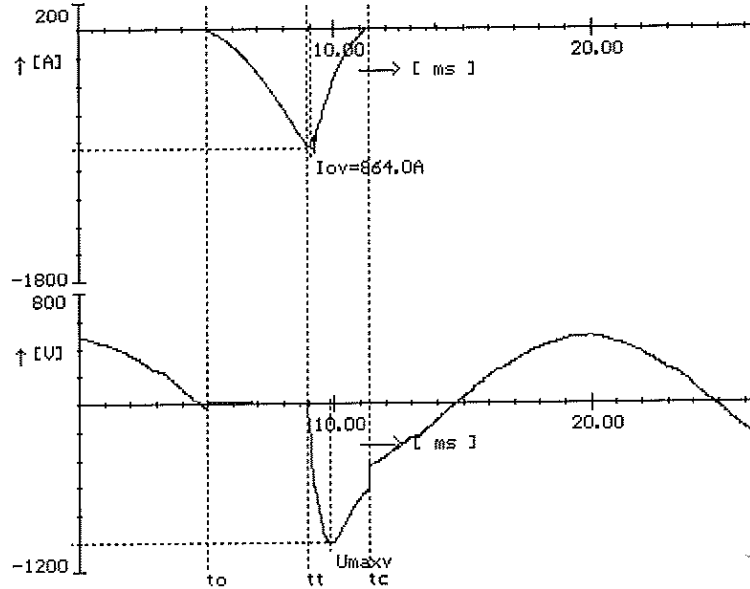

Handwritten signature and scribbles on the right side of the page.

PV10gG, In = 20 A, dU = 80 mV, č.23

Záznam číslo 99973 ze dne 8. 6.2006

Nastavené hodnoty

Ip = 793.37 A
 Uef = 332 V
 cosφ = 0.28

Naměřené hodnoty

tt = 3.93 ms
 tc = 6.37 ms
 It = 840.00 A
 Io = 872.00 A
 Umax = 1032 V
 Uzot = 336 V
 I2tt = 731.85 A2s
 I2tc = 1236.53 A2s
 Alfa = 5 st.el.
 Psi = 75 st.el.
 It = 1.06 × Ip
 Ri = 9999.00 MOhm

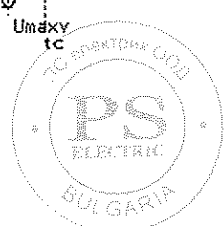
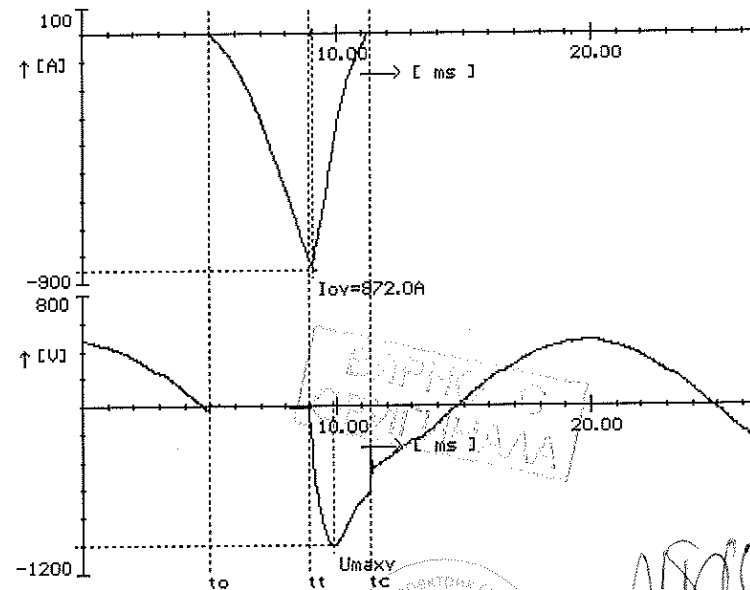

Handwritten signature and the number '86' at the bottom right.

Handwritten signature at the bottom left.

TEST REPORT

IEC 60269-1:98 3rd ed.+ Amd1:05; IEC 60269-2: 2nd ed.+ Amd1:95+ Amd2:01; IEC 60269-2-1:04 4th ed.

PU10g6, In = 25 A, dU = 76 mV, č. 23

Záznam číslo 99975 ze dne 8. 6.2006

Nastavené hodnoty

Ip = 543,77 A
 Uef = 320 V
 cosφi = 0,23

Naměřené hodnoty

tt = 5,80 ms
 tc = 8,30 ms
 It = 916,00 A
 Io = 916,00 A
 Umax = 1144 V
 Uzot = 328 V
 I2tt = 1398,31 A2s
 I2tc = 2073,68 A2s
 Alfa = 4 st.el.
 Psi = 108 st.el.
 It = 1,68 x Ip
 Ri = 9999,00 MOhm

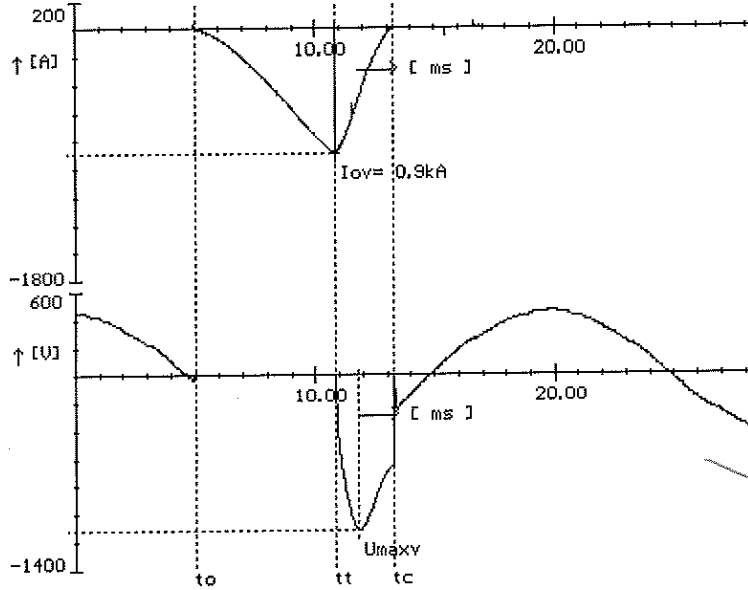

[Handwritten signature]

PU10g6, In = 25 A, dU = 76 mV, č. 24

Záznam číslo 99976 ze dne 8. 6.2006

Nastavené hodnoty

Ip = 543,77 A
 Uef = 320 V
 cosφi = 0,23

Naměřené hodnoty

tt = 5,73 ms
 tc = 8,50 ms
 It = 888,00 A
 Io = 900,00 A
 Umax = 1072 V
 Uzot = 320 V
 I2tt = 1255,41 A2s
 I2tc = 2044,06 A2s
 Alfa = 1 st.el.
 Psi = 104 st.el.
 It = 1,63 x Ip
 Ri = 9999,00 MOhm

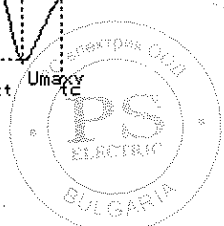
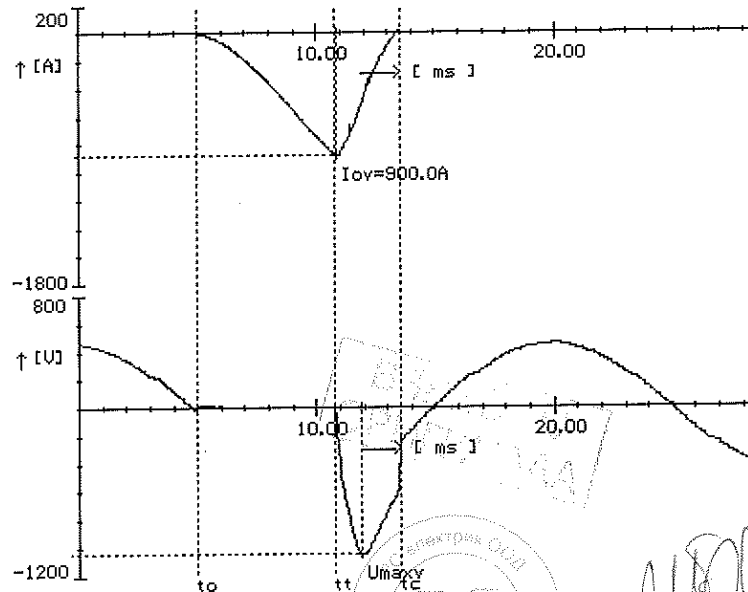

[Handwritten signature]

[Handwritten signature]

TEST REPORT

IEC 60269-1:98 3rd ed.+ Amd1:05; IEC 60269-2: 2nd ed.+ Amd1:95+ Amd2:01; IEC 60269-2-1:04 4th ed.

PU10g0, In = 25 A, dU = 74 mV, č.25

Záznam číslo 99964 ze dne 8. 6.2006

Nastavené hodnoty

Ip = 1010 A
 Uef = 340 V
 cosφ = 0.26

Naměřené hodnoty

tt = 4.00 ms
 tc = 6.30 ms
 It = 1072 A
 Io = 1088 A
 Umax = 1112 V
 Uzot = 344 V
 I2tt = 1199.52 A2s
 I2tc = 1967.25 A2s
 Alfa = 5 st.el.
 Psi = 76 st.el.
 It = 1.06 × Ip
 Ri = 9993.00 MOhm

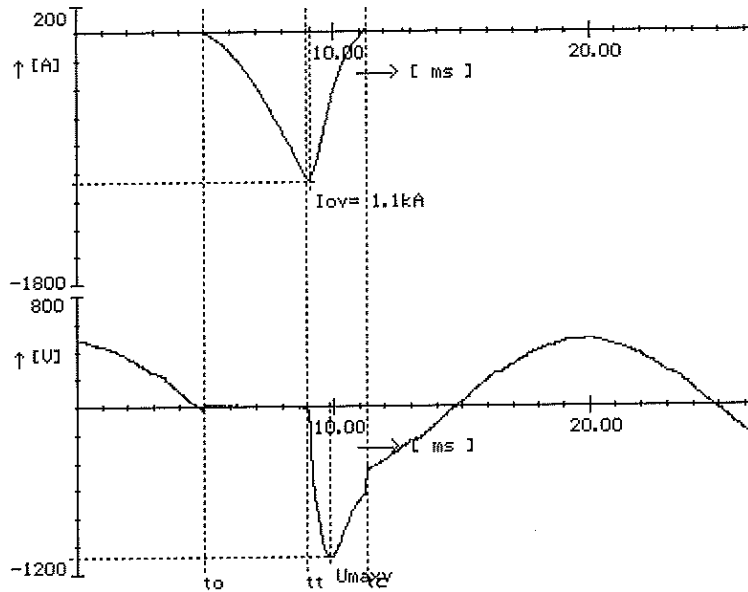

[Handwritten signature]

PU10g0, In = 25 A, dU = 74 mV, č.26

Záznam číslo 99965 ze dne 8. 6.2006

Nastavené hodnoty

Ip = 1010 A
 Uef = 340 V
 cosφ = 0.26

Naměřené hodnoty

tt = 3.80 ms
 tc = 6.27 ms
 It = 1072 A
 Io = 1092 A
 Umax = 1112 V
 Uzot = 344 V
 I2tt = 1177.36 A2s
 I2tc = 1986.90 A2s
 Alfa = 8 st.el.
 Psi = 76 st.el.
 It = 1.06 × Ip
 Ri = 9999.00 MOhm

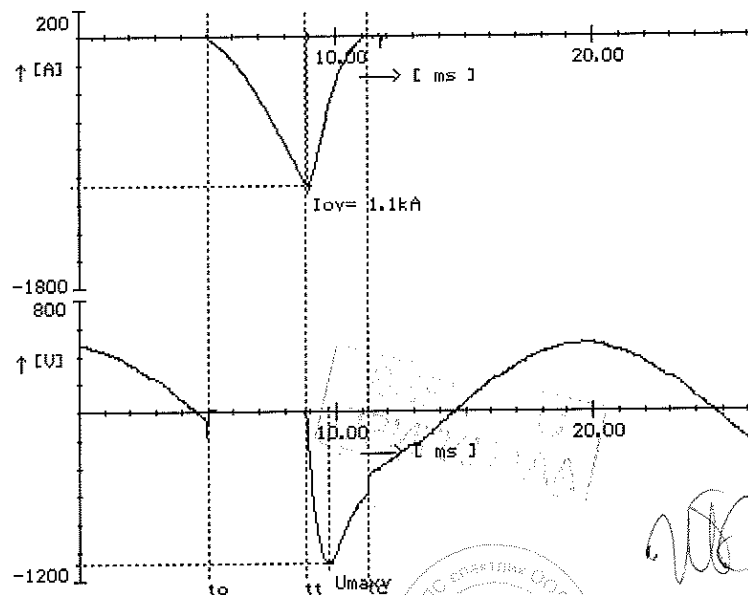

[Handwritten signature]

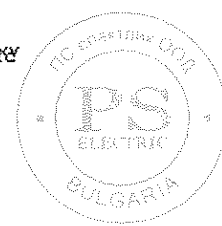

[Handwritten signature]

TEST REPORT

IEC 60269-1:98 3rd ed.+ Amd1:05; IEC 60269-2: 2nd ed.+ Amd1:95+ Amd2:01; IEC 60269-2-1:04 4th ed.

PV10g6, In = 32 A, dU = 60.5 mV, č.25

Záznam číslo 99961 ze dne 8. 6.2006

Nastavené hodnoty

Ip = 1220 A
Uef = 312 V
cosφf = 0.28

Naměřené hodnoty

tt = 4.67 ms
tc = 6.87 ms
It = 1664 A
Io = 1664 A
Umax = 1184 V
Uzot = 328 V
I2tt = 3596.55 A2s
I2tc = 4939.33 A2s
Alfa = 6 st.el.
Psi = 89 st.el.
It = 1.36 × Ip
Ri = 9999.00 MOhm

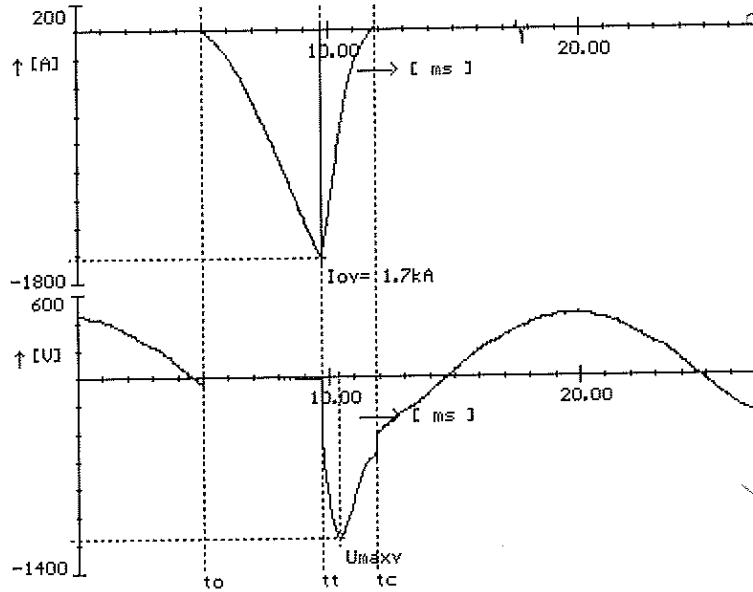

Handwritten signature and notes on the right side of the first test report.

PV10g6, In = 32 A, dU = 60 mV, č.26

Záznam číslo 99962 ze dne 8. 6.2006

Nastavené hodnoty

Ip = 1220 A
Uef = 312 V
cosφf = 0.28

Naměřené hodnoty

tt = 4.97 ms
tc = 7.20 ms
It = 1632 A
Io = 1640 A
Umax = 1168 V
Uzot = 320 V
I2tt = 3441.76 A2s
I2tc = 4816.47 A2s
Alfa = 0 st.el.
Psi = 89 st.el.
It = 1.34 × Ip
Ri = 9999.00 MOhm

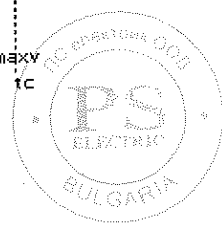
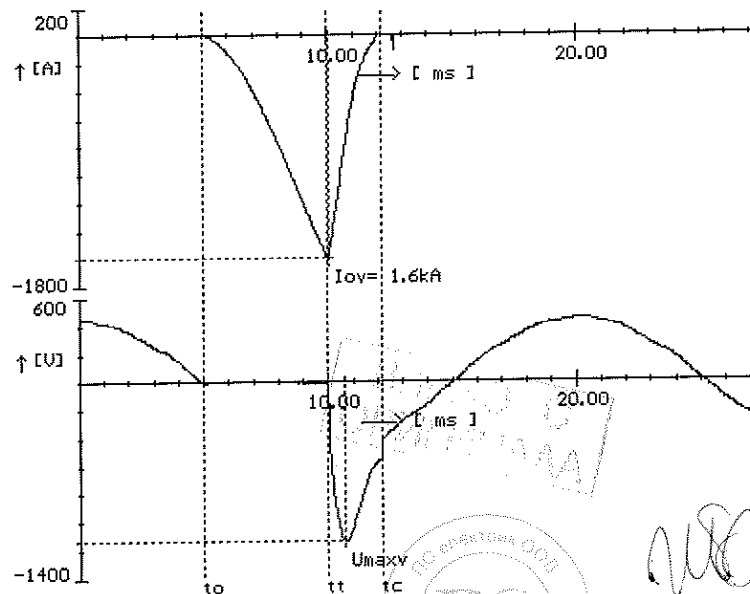

Handwritten signature and notes on the right side of the second test report.

90

Handwritten signature at the bottom left of the page.

IEC**IECEE
CB
SCHEME**

Ref. Certif. No.

CZ-1823IEC SYSTEM FOR MUTUAL RECOGNITION OF TEST
CERTIFICATES FOR ELECTRICAL EQUIPMENT
(IECEE) CB SCHEMESYSTEME CEI D'ACCEPTATION MUTUELLE DE
CERTIFICATS D'ESSAIS DES EQUIPEMENTS
ELECTRIQUES (IECEE) METHODE OC**CB TEST CERTIFICATE
CERTIFICAT D'ESSAI OC**Product
Produit

Low-voltage fuses

Name and address of the applicant
Nom et adresse du demandeurOEZ s. r. o.
Šedivská 339, 561 51 Letohrad, Czech RepublicName and address of the manufacturer
Nom et adresse du fabricantOEZ s. r. o.
Šedivská 339, 561 51 Letohrad, Czech RepublicName and address of the factory
Nom et adresse de l'usineOEZ s. r. o.
Šedivská 339, 561 51 Letohrad, Czech RepublicRatings and principal characteristics
Valeurs nominales et caractéristiques principales

500 V; 2, 4, 6, 8, 10, 12, 16, 20, 25, 32 A

Trademark (if any)
Marque de fabrique (si elle existe)Model / Type Ref.
Ref. De type

PV10 gG Cd/Pb free

Additional information (if necessary)
Information complémentaire (si nécessaire)

PUBLICATION

EDITION

A sample of the product was tested and found
to be in conformity with
Un échantillon de ce produit a été essayé et a été
considéré conforme à laIEC 60269-1
IEC 60269-2
IEC 60269-2-11998+A1:2005
1986+A1:1995+A2:2001
2004As shown in the Test Report Ref. No. which forms part
of this Certificate
Comme indiqué dans le Rapport d'essais numéro de
référence qui constitue partie de ce Certificat

702102-01/01 of: 03.08.2007

This CB Test Certificate is issued by the National Certification Body
Ce Certificat d'essai OC est établi par l'Organisme National de CertificationElektrotechnický zkušební ústav, s.p.
Pod Lisem 129, 171 02 Praha 8 – Troja
Czech Republic

Date: 7.8.2007

Signature

На основании чл. 2
от ЗЗЛД



10.7/15

Český institut pro akreditaci, o.p.s.
130 00 Praha 3, Olšanská 54/3

vydává

OSVĚDČENÍ O AKREDITACI

č. 635 / 2012

Elektrotechnický zkušební ústav, s.p.
se sídlem Pod Lisem 129, 171 02 Praha 8 - Troja, IČ 00001481

pro zkušební laboratoř č. 1056
Zkušební laboratoř

Předmět akreditace:

Zkoušení výrobků, dílů, součástí, materiálů a pomůcek v rozsahu uvedeném v příloze tohoto osvědčení.

Toto osvědčení o akreditaci vydal Český institut pro akreditaci, o.p.s. na základě posouzení splnění akreditačních požadavků podle

ČSN EN ISO/IEC 17025:2005

a po zjištění, že zkušební laboratoř je odborně způsobilá objektivně a nezávisle vykonávat činnosti uvedené v rozsahu předmětu akreditace.

Adresát tohoto osvědčení je oprávněn používat při své činnosti v rozsahu tohoto osvědčení a po dobu jeho platnosti vedle svého názvu označení „zkušební laboratoř akreditovaná ČIA č. 1056“, pod podmínkou, že bude vždy postupovat v souladu s příslušnými předpisy vztahujícími se k činnosti akreditované zkušební laboratoře, a to zejména ČSN EN ISO/IEC 17011, čl. 8.1, ČSN EN ISO/IEC 17025, zákona č. 22/1997Sb., o technických požadavcích na výrobky, ve znění pozdějších předpisů, včetně navazujících předpisů vydaných Českým institutem pro akreditaci, o.p.s.

Prokáže-li se, že adresát tohoto osvědčení neplní akreditační požadavky rozhodné pro jeho vydání a nedodrží závazky podmínující akreditaci, může Český institut pro akreditaci, o.p.s. účinnost tohoto osvědčení pozastavit nebo osvědčení o akreditaci zrušit.

Toto osvědčení je vydáno v souladu s ustanovením § 16 odst. 1 zákona č. 22/1997 Sb., o technických požadavcích na výrobky a v souladu s ustanovením § 151 zákona č. 500/2004 Sb., správní řád.

Toto osvědčení je platné do 15.10.2016

V Praze dne 07.11.2012



České

На основании чл. 2
от ЗЗЛД

92

Чешки институт по акредитация
130 00 Прага 3, Олшанска 54/3

издава

УДОСТОВЕРЕНИЕ ЗА АКРЕДИТАЦИЯ

№ 635 /2012

на
Изпитвателна лаборатория №1056
Електротехнически изпитвателен институт , държ.предпр.
Под Лисем 129, 171 02 Прага 8 – Троя, Ин № 00001481

Предмет на акредитацията

Изпитване на изделия, детайли, части, материали и пособия до степента, определена в Приложението на това удостоверение.

Това свидетелство за акредитация се издава от Чешкия институт по акредитация СОД въз основа на оценката и изпълнението на критериите за акредитация съгласно

CSN EN ISO/IEC 17025:2005

и след констатацията и установяване обективно и независимо, че лабораторията за изпитване е компетентна да извърши дейностите, включени в обхвата на предмета на акредитацията. Адресатът на удостоверението е упълномощен да го използва в своята дейност в този обхват и време на валидност, добавяйки към своето название и обозначението „акредитирана изпитвателна лаборатория №1056“, ако спазва всички съответстващи предписания, отнасящи се до дейността на акредитираната изпитвателна лаборатория, включително предписанията, издадени от Чешкия институт по акредитация СОД.

При условие че адресатът на това свидетелство не изпълнява критериите за акредитация, приложими към издаването му и задълженията произтичащи от акредитацията, то Чешкия институт по акредитация СОД., може да преустанови удостоверението за акредитация или да го отмени, или измени.

Настоящото удостоверение се издава в съответствие с § 16 от Закон № 22 / 1997., за техническите изисквания към продуктите и в съответствие с разпоредбите на §15, от Закон № 500/2004, Административно-процесуален.

Настоящото удостоверение е в сила до 15.10.2017 г.

Прага , 07.11.2012г.

На основание чл. 2
от ЗЗЛД

Чешки институт по акредитация СОД



Handwritten signature

93

Handwritten signature

Large handwritten signature

Списък на Проведените изпитания

- 8.5 No 1 Изключвателна способност (I₁)
- 8.5 No 2 Изключвателна способност (I₂)
- 8.5 No 2 Изключвателна способност (I₃)
- 8.5 No 2 Изключвателна способност (I₄)
- 8.5 No 2 Изключвателна способност (I₅)
- 8.7.4 Термично претоварване
- 8.9.2 Устойчивост на температура
- 8.11.1.8 Устойчивост на удар
- 8.11.2.2 Устойчивост на свръх нормална температура и огън
- 8.11.2.4 Проверка за ненарушимостта на изолиращите части



УЧЕНО С
ОПРЕДЕЛЕНИЕ

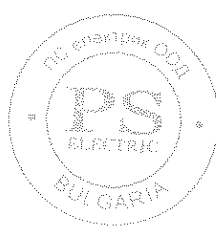

10.7.6.

Инструкция за транспортиране, складиране, монтиране, вкл. Въртящият момент на затягане на клемовите съединения, обслужване и поддръжане.

предпазител-прекъсвач-разединители с цилиндрични стопяеми вложки

1

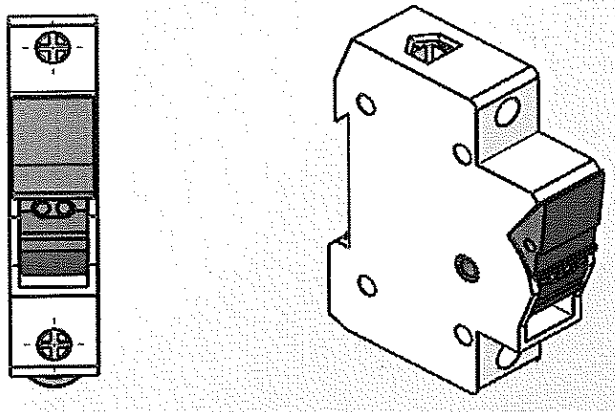

Инсталирането, експлоатация и поддръжката на електрическото оборудване трябва да се извършват единствено от оторизиран персонал.

2

Монтаж / Демонтаж.

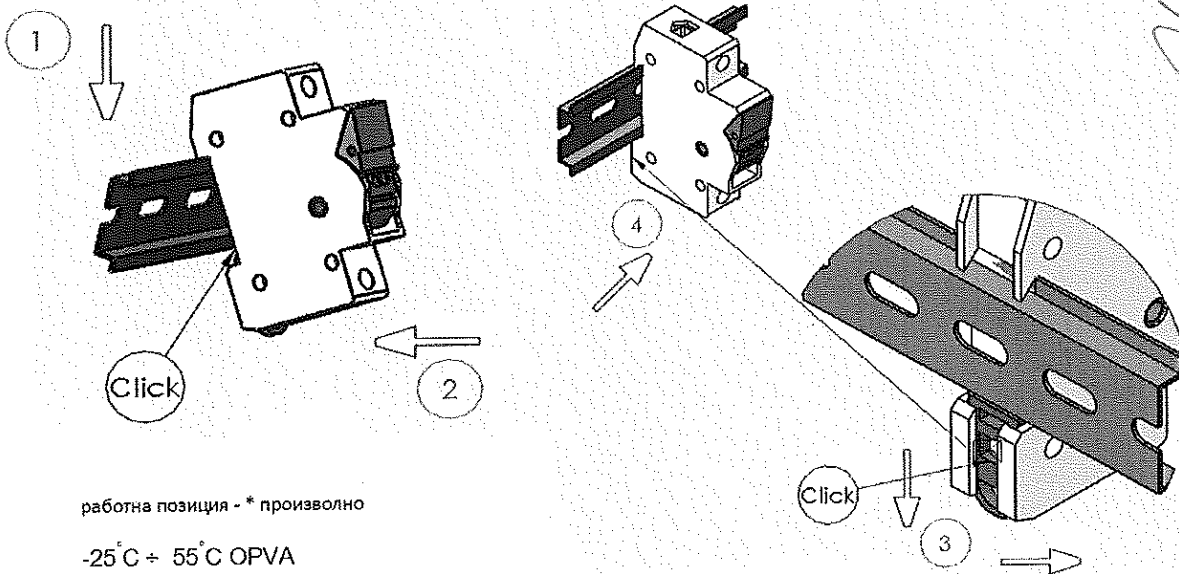

работна позиция - * произволно

-25°C ÷ 55°C OPVA

-25°C ÷ 55°C OPVP



[Handwritten signature]

95

3

Свързване

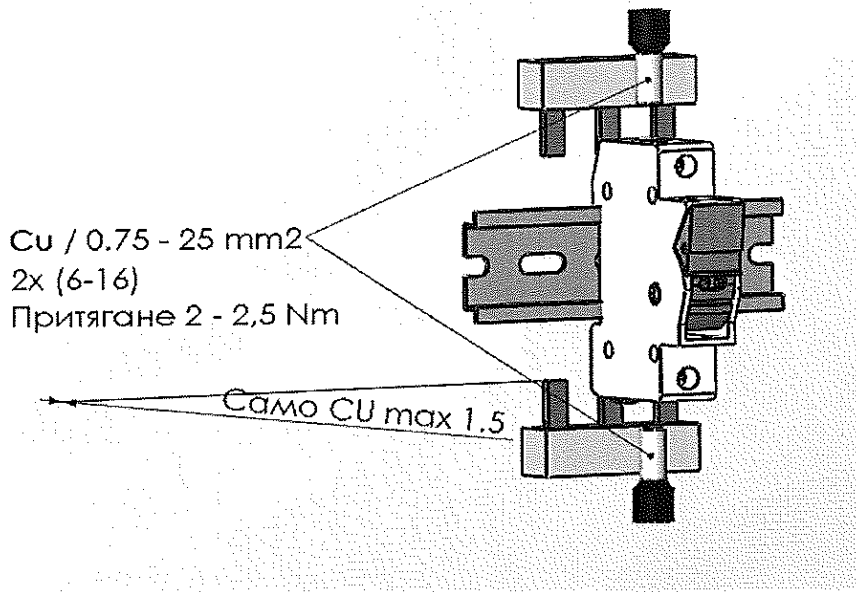

4 Само материали, които имат нисък неблагоприятен екологичен ефект и които не съдържат опасни вещества, както е посочено в директивата ROHS, са използвани в продукта.

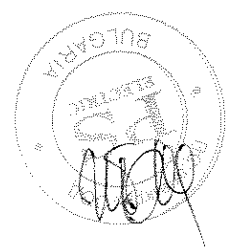

96